



Product Specification

M270HVN02.0

AU OPTRONICS CORPORATION

() Preliminary Specification
(V) Final Specification

Module	27.0" Color TFT-LCD
Model Name	M270HVN02.0 (ES7.0 from 00B)

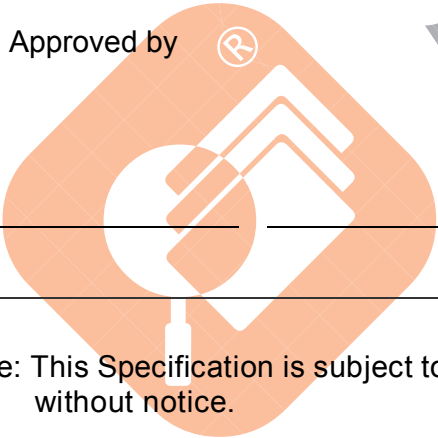
Customer	Date
_____	_____
Approved by 	
	_____
Note: This Specification is subject to change without notice.	

Approved by	Date
<u>Howard Lee</u>	<u>2016/5/24</u>
Prepared by	
<u>Bryent Lee</u>	<u>2016/5/23</u>
Desktop Display Business Group / AU Optronics Corporation	

Content

1 HANDING PRECAUTIONS	7
2 GENERAL DESCRIPTION	8
2.1 Display Characteristics.....	8
2.2 Absolute Ratings of Environment.....	9
2.3 Optical Characteristics.....	10
2.4 Mechanical Characteristics.....	14
3 TFT-LCD Module	15
3.1 Block Diagram.....	15
3.2 Interface Connection.....	16
3.2.1 Connector Type.....	16
3.2.2 Connector Pin Assignment.....	16
3.3 Electrical Characteristics.....	18
3.3.1 Absolute Maximum Rating.....	18
3.3.2 Recommended Operating Condition.....	19
3.4 Signal Characteristics.....	20
3.4.1 LCD Pixel Format.....	20
3.4.2 LVDS Data Format.....	20
3.4.3 Color versus Input Data.....	21
3.4.4 LVDS Specification.....	21
3.4.5 Input Timing Specification.....	23
3.4.6 Input Timing Diagram.....	24
3.5 Power ON/OFF Sequence.....	25
4 Backlight Unit	26
4.1 Block Diagram.....	26
4.2 Interface Connection.....	27
4.2.1 Connector Type.....	27
4.2.2 Connector Pin Assignment.....	28
4.3 Electrical Characteristics.....	29
4.3.1 Absolute Maximum Rating.....	29
4.3.2 Recommended Operating Condition.....	30
5 Reliability Test	32
6 Shipping Label	33
7 Mechanical Characteristics	34
8 Packing Specification	37
8.1 Packing Flow.....	37
8.2 Pallet and shipment information.....	38

Records of Revision

Version and Date	Page	Old description	New Description	Remark				
0.1 2012/05/10		First Version						
0.2 2012/06/15	14, 18		To Define TFT LCD power spec To Define BL Power spec					
0.3 2012/06/20	6		To Define Panel Weight					
0.3 2012/06/20	31		<p>To Change the Label position. BLU Label is at the upper right (corner). Shipping label is at the the upper left (corner).</p>					
0.4 2012/06/29	14	Verison 0.3 , the absolute VDD maximum is 5.5V of the module	Verison 0.4 , Update the absolute VDD maximum is 6.0V of the module					
0.5 2012/07/12	6, 7, 14	In Verison 0.4 , Surface Treatment , Color/Chromaticity , absolute rating as TBD .	To Define the Surface Treatment To Define Color / Chromaticity (should be confirm again) To Define the Absolute Maximum Ratings of BL unit					
0.5 2012/07/12	23, 19	In Verison 0.4 , the Max clock is 85MHz. In Verison 0.4 , the VLB minmun doesn't defined.	To upgrade the Max clock frequency as 90MHz. To define the VLB minnum voltage .					
0.6 2012/07/25	6		To correct the model name as M270HVN02.0					
0.7 2012/08/20	6	<table border="1"> <tr> <td>[Watt]</td> <td>29.34 watt VDD line : PDD (typ), All white pattern at 60Hz = 5.94 W LED line : PBLU (typ) = 23.4 W</td> </tr> </table>	[Watt]	29.34 watt VDD line : PDD (typ), All white pattern at 60Hz = 5.94 W LED line : PBLU (typ) = 23.4 W	<p>To modify the Panel Power Consumption</p> <table border="1"> <tr> <td>[Watt]</td> <td>27.72 watt VDD line : PDD (typ), All white pattern at 60Hz = 5.94 W LED line : PBLU (typ) = 21.78 W</td> </tr> </table>	[Watt]	27.72 watt VDD line : PDD (typ), All white pattern at 60Hz = 5.94 W LED line : PBLU (typ) = 21.78 W	
[Watt]	29.34 watt VDD line : PDD (typ), All white pattern at 60Hz = 5.94 W LED line : PBLU (typ) = 23.4 W							
[Watt]	27.72 watt VDD line : PDD (typ), All white pattern at 60Hz = 5.94 W LED line : PBLU (typ) = 21.78 W							



0.7 2012/08/20	7	<table border="1"> <tr> <td>Red x</td> <td>0.612</td> <td>0.642</td> <td>0.672</td> </tr> <tr> <td>Red y</td> <td>0.304</td> <td>0.334</td> <td>0.364</td> </tr> <tr> <td>Green x</td> <td>0.292</td> <td>0.322</td> <td>0.352</td> </tr> <tr> <td>Green y</td> <td>0.594</td> <td>0.624</td> <td>0.654</td> </tr> <tr> <td>Blue x</td> <td>0.126</td> <td>0.156</td> <td>0.186</td> </tr> <tr> <td>Blue y</td> <td>0.030</td> <td>0.060</td> <td>0.090</td> </tr> </table>	Red x	0.612	0.642	0.672	Red y	0.304	0.334	0.364	Green x	0.292	0.322	0.352	Green y	0.594	0.624	0.654	Blue x	0.126	0.156	0.186	Blue y	0.030	0.060	0.090	To modify the Color / Chromaticity Coordinates (CIE)	<table border="1"> <tr> <td>Red x</td> <td>0.615</td> <td>0.645</td> <td>0.675</td> </tr> <tr> <td>Red y</td> <td>0.300</td> <td>0.330</td> <td>0.360</td> </tr> <tr> <td>Green x</td> <td>0.285</td> <td>0.315</td> <td>0.345</td> </tr> <tr> <td>Green y</td> <td>0.590</td> <td>0.620</td> <td>0.650</td> </tr> <tr> <td>Blue x</td> <td>0.124</td> <td>0.154</td> <td>0.184</td> </tr> <tr> <td>Blue y</td> <td>0.034</td> <td>0.064</td> <td>0.094</td> </tr> </table>	Red x	0.615	0.645	0.675	Red y	0.300	0.330	0.360	Green x	0.285	0.315	0.345	Green y	0.590	0.620	0.650	Blue x	0.124	0.154	0.184	Blue y	0.034	0.064	0.094								
Red x	0.612	0.642	0.672																																																									
Red y	0.304	0.334	0.364																																																									
Green x	0.292	0.322	0.352																																																									
Green y	0.594	0.624	0.654																																																									
Blue x	0.126	0.156	0.186																																																									
Blue y	0.030	0.060	0.090																																																									
Red x	0.615	0.645	0.675																																																									
Red y	0.300	0.330	0.360																																																									
Green x	0.285	0.315	0.345																																																									
Green y	0.590	0.620	0.650																																																									
Blue x	0.124	0.154	0.184																																																									
Blue y	0.034	0.064	0.094																																																									
0.7 2012/08/20	18	<table border="1"> <thead> <tr> <th>Symbol</th> <th>Description</th> <th>Min.</th> <th>Typ.</th> <th>Max.</th> <th>Unit</th> <th>Note</th> </tr> </thead> <tbody> <tr> <td>IRLED</td> <td>LED Over-ster Current</td> <td>-</td> <td>120</td> <td>120</td> <td>[mA]</td> <td>Note 1</td> </tr> <tr> <td>VLB</td> <td>Light Bar Operation Voltage (for reference)</td> <td>44.25</td> <td>49.75</td> <td>53.25</td> <td>[Vdc]</td> <td>Note 2</td> </tr> <tr> <td>PBLU</td> <td>BLU Power Consumption (for reference)</td> <td>-</td> <td>23.4</td> <td>25.3</td> <td>[Watt]</td> <td>Note 3</td> </tr> </tbody> </table>	Symbol	Description	Min.	Typ.	Max.	Unit	Note	IRLED	LED Over-ster Current	-	120	120	[mA]	Note 1	VLB	Light Bar Operation Voltage (for reference)	44.25	49.75	53.25	[Vdc]	Note 2	PBLU	BLU Power Consumption (for reference)	-	23.4	25.3	[Watt]	Note 3	To modify the BLU power spec	<table border="1"> <thead> <tr> <th>Symbol</th> <th>Description</th> <th>Min.</th> <th>Typ.</th> <th>Max.</th> <th>Unit</th> <th>Note</th> </tr> </thead> <tbody> <tr> <td>RIED</td> <td>LED Operat on Current</td> <td>-</td> <td>110</td> <td>115.5</td> <td>[mA]</td> <td>Note 1</td> </tr> <tr> <td>VLE</td> <td>Light Bar Operation Voltage (for reference)</td> <td>44.25</td> <td>49.5</td> <td>54</td> <td>[Vdc]</td> <td>Note 2</td> </tr> <tr> <td>PBLU</td> <td>BLU Power Consumption (for reference)</td> <td>-</td> <td>21.78</td> <td>24.95</td> <td>[Watt]</td> <td>Note 3</td> </tr> </tbody> </table>	Symbol	Description	Min.	Typ.	Max.	Unit	Note	RIED	LED Operat on Current	-	110	115.5	[mA]	Note 1	VLE	Light Bar Operation Voltage (for reference)	44.25	49.5	54	[Vdc]	Note 2	PBLU	BLU Power Consumption (for reference)	-	21.78	24.95	[Watt]	Note 3
Symbol	Description	Min.	Typ.	Max.	Unit	Note																																																						
IRLED	LED Over-ster Current	-	120	120	[mA]	Note 1																																																						
VLB	Light Bar Operation Voltage (for reference)	44.25	49.75	53.25	[Vdc]	Note 2																																																						
PBLU	BLU Power Consumption (for reference)	-	23.4	25.3	[Watt]	Note 3																																																						
Symbol	Description	Min.	Typ.	Max.	Unit	Note																																																						
RIED	LED Operat on Current	-	110	115.5	[mA]	Note 1																																																						
VLE	Light Bar Operation Voltage (for reference)	44.25	49.5	54	[Vdc]	Note 2																																																						
PBLU	BLU Power Consumption (for reference)	-	21.78	24.95	[Watt]	Note 3																																																						
0.7 2012/08/20	13	VDD minimum is 0V LED forward Voltage variation(ΔV_f) is 6V	To modify the VDD minimum as -0.3V LED forward Voltage variation(ΔV_f) as 3V																																																									
1.0 2012/10/08	6	The 0.7 verison power consumption is 27.72W	Update the power consumption 26.88W																																																									
	6		TCO Compliance :TCO 6.0																																																									
	14		To Define Max. Value IDD1 and PDD1																																																									
	22		Add Hsync Frequency																																																									
	30	Note 3:TORQUE OF M2 USER HOLE SHOULD BE WITHIN 4kgf-cm	Update Note3:TORQUE OF M2 USER HOLE SHOULD BE WITHIN 3kgf-cm																																																									
1.1 2012/12/4	34		To Modify the Ch 11-2 Panel dimension with 613.6(H)mm x 356.85(V)mm x 10(D)mm																																																									
	18		To Correct the Note3 , VLED changed VLB																																																									
	20/21/25	<table border="1"> <thead> <tr> <th>Pin#</th> <th>Signal Name</th> <th>Pin#</th> <th>Signal Name</th> </tr> </thead> <tbody> <tr> <td>1</td> <td>RxOIN0-</td> <td>2</td> <td>RxOIN0+</td> </tr> <tr> <td>3</td> <td>RxOIN1-</td> <td>4</td> <td>RxOIN1+</td> </tr> <tr> <td>5</td> <td>RxOIN2-</td> <td>6</td> <td>RxOIN2+</td> </tr> <tr> <td>7</td> <td>GND</td> <td>8</td> <td>RxOCLKIN-</td> </tr> <tr> <td>9</td> <td>RxOCLKIN+</td> <td>10</td> <td>RxOIN3-</td> </tr> <tr> <td>11</td> <td>RxOIN3+</td> <td>12</td> <td>RxEIN0-</td> </tr> </tbody> </table>	Pin#	Signal Name	Pin#	Signal Name	1	RxOIN0-	2	RxOIN0+	3	RxOIN1-	4	RxOIN1+	5	RxOIN2-	6	RxOIN2+	7	GND	8	RxOCLKIN-	9	RxOCLKIN+	10	RxOIN3-	11	RxOIN3+	12	RxEIN0-	Re-named the LVDS Signal																													
Pin#	Signal Name	Pin#	Signal Name																																																									
1	RxOIN0-	2	RxOIN0+																																																									
3	RxOIN1-	4	RxOIN1+																																																									
5	RxOIN2-	6	RxOIN2+																																																									
7	GND	8	RxOCLKIN-																																																									
9	RxOCLKIN+	10	RxOIN3-																																																									
11	RxOIN3+	12	RxEIN0-																																																									
			<table border="1"> <thead> <tr> <th>Pin#</th> <th>Signal Name</th> <th>Pin#</th> <th>Signal Name</th> </tr> </thead> <tbody> <tr> <td>1</td> <td>RxO0-</td> <td>2</td> <td>RxO0+</td> </tr> <tr> <td>3</td> <td>RxO1-</td> <td>4</td> <td>RxO1+</td> </tr> <tr> <td>5</td> <td>RxO2-</td> <td>6</td> <td>RxO2+</td> </tr> <tr> <td>7</td> <td>GND</td> <td>8</td> <td>RxOCLK-</td> </tr> <tr> <td>9</td> <td>RxOCLK+</td> <td>10</td> <td>RxO3-</td> </tr> <tr> <td>11</td> <td>RxO3+</td> <td>12</td> <td>RxE0-</td> </tr> </tbody> </table>	Pin#	Signal Name	Pin#	Signal Name	1	RxO0-	2	RxO0+	3	RxO1-	4	RxO1+	5	RxO2-	6	RxO2+	7	GND	8	RxOCLK-	9	RxOCLK+	10	RxO3-	11	RxO3+	12	RxE0-																													
Pin#	Signal Name	Pin#	Signal Name																																																									
1	RxO0-	2	RxO0+																																																									
3	RxO1-	4	RxO1+																																																									
5	RxO2-	6	RxO2+																																																									
7	GND	8	RxOCLK-																																																									
9	RxOCLK+	10	RxO3-																																																									
11	RxO3+	12	RxE0-																																																									
1.2 2012/12/27	12/18/26	<p>Old naming</p> <table border="1"> <thead> <tr> <th>Symbol</th> <th>Description</th> </tr> </thead> <tbody> <tr> <td>IRLED1</td> <td rowspan="4">LED Forward Current</td> </tr> <tr> <td>IRLED2</td> </tr> <tr> <td>IRLED3</td> </tr> <tr> <td>IRLED4</td> </tr> <tr> <td>VLB</td> <td>Light Bar Operation Voltage (for reference)</td> </tr> </tbody> </table>	Symbol	Description	IRLED1	LED Forward Current	IRLED2	IRLED3	IRLED4	VLB	Light Bar Operation Voltage (for reference)	<p>New naming :</p> <table border="1"> <thead> <tr> <th>Symbol</th> <th>Description</th> </tr> </thead> <tbody> <tr> <td>IFLED1</td> <td rowspan="4">LED Forward Current</td> </tr> <tr> <td>IFLED2</td> </tr> <tr> <td>IFLED3</td> </tr> <tr> <td>IFLED4</td> </tr> <tr> <td>VSLED</td> <td>Light Bar Operation Voltage (for reference)</td> </tr> </tbody> </table>	Symbol	Description	IFLED1	LED Forward Current	IFLED2	IFLED3	IFLED4	VSLED	Light Bar Operation Voltage (for reference)																																							
Symbol	Description																																																											
IRLED1	LED Forward Current																																																											
IRLED2																																																												
IRLED3																																																												
IRLED4																																																												
VLB	Light Bar Operation Voltage (for reference)																																																											
Symbol	Description																																																											
IFLED1	LED Forward Current																																																											
IFLED2																																																												
IFLED3																																																												
IFLED4																																																												
VSLED	Light Bar Operation Voltage (for reference)																																																											
1.3 2013/2/26	7		To define the maximun value of response time																																																									
1.4 2013/4/12	20/25	Pin25/Pin 27 is ground pin	Re-define the Pin assignment Pin25/Pin27 as NC																																																									
1.5	31/32/33	Without shading mylar on front bezel surface	Adding mylar on front bezel surface																																																									

2013/5/6																																																																																														
	19	Maximum of Power is 24.95	Recommendation for LED driver power design: To Modify the Maximum of Power is 23.76																																																																																											
	34/35	To modify the pallet and shipment information, before the packing box is 9pcs/Box and the weight of pallet of packing is 216kg.	After modifying, the packing box is 10pcs/Box and the weight of pallet of packing is 229.94kg.																																																																																											
	All	Change to new format																																																																																												
	8	2.1 Display Characteristics <table border="1"> <tr> <td>Power Consumption (VDD line + LED line)</td> <td>[Watt]</td> <td>26.88 watt (VDD line : PDD (typ), All white pattern at 60Hz = 5.1 W, LED line : PBLU (typ) = 21.78 W @ 110mA)</td> </tr> </table>	Power Consumption (VDD line + LED line)	[Watt]	26.88 watt (VDD line : PDD (typ), All white pattern at 60Hz = 5.1 W, LED line : PBLU (typ) = 21.78 W @ 110mA)	2.1 Display Characteristics <table border="1"> <tr> <td>Power Consumption (VDD line + LED line)</td> <td>[Watt]</td> <td>19.53 watt (VDD line : PDD (typ), All white pattern at 60Hz = 4.66 W, LED line : PBLU (typ) = 14.88 W @ 80mA)</td> </tr> </table>	Power Consumption (VDD line + LED line)	[Watt]	19.53 watt (VDD line : PDD (typ), All white pattern at 60Hz = 4.66 W, LED line : PBLU (typ) = 14.88 W @ 80mA)																																																																																					
Power Consumption (VDD line + LED line)	[Watt]	26.88 watt (VDD line : PDD (typ), All white pattern at 60Hz = 5.1 W, LED line : PBLU (typ) = 21.78 W @ 110mA)																																																																																												
Power Consumption (VDD line + LED line)	[Watt]	19.53 watt (VDD line : PDD (typ), All white pattern at 60Hz = 4.66 W, LED line : PBLU (typ) = 14.88 W @ 80mA)																																																																																												
	10	2.3 Optical Characteristics <table border="1"> <thead> <tr> <th>Color / Chromaticity Coordinates (CIE)</th> <th>Red x^o</th> <th>Red y^o</th> <th>Green x^o</th> <th>Green y^o</th> <th>Blue x^o</th> <th>Blue y^o</th> </tr> </thead> <tbody> <tr> <td></td> <td>0.615</td> <td>0.645</td> <td>0.675</td> <td>0.360</td> <td>0.154</td> <td>0.094</td> </tr> <tr> <td></td> <td>0.300</td> <td>0.330</td> <td>0.360</td> <td>0.285</td> <td>0.315</td> <td>0.345</td> </tr> <tr> <td></td> <td>0.590</td> <td>0.620</td> <td>0.650</td> <td>0.124</td> <td>0.154</td> <td>0.184</td> </tr> <tr> <td></td> <td>0.034</td> <td>0.064</td> <td>0.094</td> <td></td> <td></td> <td></td> </tr> </tbody> </table>	Color / Chromaticity Coordinates (CIE)	Red x ^o	Red y ^o	Green x ^o	Green y ^o	Blue x ^o	Blue y ^o		0.615	0.645	0.675	0.360	0.154	0.094		0.300	0.330	0.360	0.285	0.315	0.345		0.590	0.620	0.650	0.124	0.154	0.184		0.034	0.064	0.094				2.3 Optical Characteristics <table border="1"> <thead> <tr> <th>Color / Chromaticity Coordinates (CIE)</th> <th>Red x^o</th> <th>Red y^o</th> <th>Green x^o</th> <th>Green y^o</th> <th>Blue x^o</th> <th>Blue y^o</th> </tr> </thead> <tbody> <tr> <td></td> <td>0.610</td> <td>0.640</td> <td>0.670</td> <td>0.363</td> <td>0.156</td> <td>0.095</td> </tr> <tr> <td></td> <td>0.303</td> <td>0.333</td> <td>0.363</td> <td>0.290</td> <td>0.320</td> <td>0.350</td> </tr> <tr> <td></td> <td>0.590</td> <td>0.620</td> <td>0.650</td> <td>0.126</td> <td>0.156</td> <td>0.186</td> </tr> <tr> <td></td> <td>0.025</td> <td>0.055</td> <td>0.085</td> <td></td> <td></td> <td></td> </tr> </tbody> </table>	Color / Chromaticity Coordinates (CIE)	Red x ^o	Red y ^o	Green x ^o	Green y ^o	Blue x ^o	Blue y ^o		0.610	0.640	0.670	0.363	0.156	0.095		0.303	0.333	0.363	0.290	0.320	0.350		0.590	0.620	0.650	0.126	0.156	0.186		0.025	0.055	0.085																								
Color / Chromaticity Coordinates (CIE)	Red x ^o	Red y ^o	Green x ^o	Green y ^o	Blue x ^o	Blue y ^o																																																																																								
	0.615	0.645	0.675	0.360	0.154	0.094																																																																																								
	0.300	0.330	0.360	0.285	0.315	0.345																																																																																								
	0.590	0.620	0.650	0.124	0.154	0.184																																																																																								
	0.034	0.064	0.094																																																																																											
Color / Chromaticity Coordinates (CIE)	Red x ^o	Red y ^o	Green x ^o	Green y ^o	Blue x ^o	Blue y ^o																																																																																								
	0.610	0.640	0.670	0.363	0.156	0.095																																																																																								
	0.303	0.333	0.363	0.290	0.320	0.350																																																																																								
	0.590	0.620	0.650	0.126	0.156	0.186																																																																																								
	0.025	0.055	0.085																																																																																											
	18	3.3.2 Recommended Operating Condition <table border="1"> <thead> <tr> <th>Symbol</th> <th>Description</th> <th>Min.</th> <th>Typ.</th> <th>Max.</th> <th>Unit</th> <th>Remark</th> </tr> </thead> <tbody> <tr> <td>VDD</td> <td>Power supply input voltage</td> <td>4.5</td> <td>5.0</td> <td>5.5</td> <td>[VOLT]</td> <td></td> </tr> <tr> <td>IDD</td> <td>Power supply Input Current (typ)</td> <td>1.02</td> <td>1.22</td> <td>1.42</td> <td>[A]</td> <td>VDD=5.0V, All white Pattern at 60 Hz</td> </tr> <tr> <td>PDD</td> <td>VDD Power Consumption</td> <td>5.1</td> <td>6.05</td> <td>7.26</td> <td>[Watt]</td> <td>VDD=5.0V, All white Pattern at 60 Hz</td> </tr> </tbody> </table>	Symbol	Description	Min.	Typ.	Max.	Unit	Remark	VDD	Power supply input voltage	4.5	5.0	5.5	[VOLT]		IDD	Power supply Input Current (typ)	1.02	1.22	1.42	[A]	VDD=5.0V, All white Pattern at 60 Hz	PDD	VDD Power Consumption	5.1	6.05	7.26	[Watt]	VDD=5.0V, All white Pattern at 60 Hz	3.3.2 Recommended Operating Condition <table border="1"> <thead> <tr> <th>Symbol</th> <th>Description</th> <th>Min.</th> <th>Typ.</th> <th>Max.</th> <th>Unit</th> <th>Remark</th> </tr> </thead> <tbody> <tr> <td>VDD</td> <td>Power supply input voltage</td> <td>4.5</td> <td>5.0</td> <td>5.5</td> <td>[VOLT]</td> <td></td> </tr> <tr> <td>IDD</td> <td>Power supply Input Current (typ)</td> <td>0.93</td> <td>1.12</td> <td>1.44</td> <td>[A]</td> <td>VDD=5.0V, All white Pattern at 60 Hz</td> </tr> <tr> <td>PDD</td> <td>VDD Power Consumption</td> <td>4.65</td> <td>5.58</td> <td>7.36</td> <td>[Watt]</td> <td>VDD=5.0V, All white Pattern at 60 Hz</td> </tr> </tbody> </table>	Symbol	Description	Min.	Typ.	Max.	Unit	Remark	VDD	Power supply input voltage	4.5	5.0	5.5	[VOLT]		IDD	Power supply Input Current (typ)	0.93	1.12	1.44	[A]	VDD=5.0V, All white Pattern at 60 Hz	PDD	VDD Power Consumption	4.65	5.58	7.36	[Watt]	VDD=5.0V, All white Pattern at 60 Hz																																			
Symbol	Description	Min.	Typ.	Max.	Unit	Remark																																																																																								
VDD	Power supply input voltage	4.5	5.0	5.5	[VOLT]																																																																																									
IDD	Power supply Input Current (typ)	1.02	1.22	1.42	[A]	VDD=5.0V, All white Pattern at 60 Hz																																																																																								
PDD	VDD Power Consumption	5.1	6.05	7.26	[Watt]	VDD=5.0V, All white Pattern at 60 Hz																																																																																								
Symbol	Description	Min.	Typ.	Max.	Unit	Remark																																																																																								
VDD	Power supply input voltage	4.5	5.0	5.5	[VOLT]																																																																																									
IDD	Power supply Input Current (typ)	0.93	1.12	1.44	[A]	VDD=5.0V, All white Pattern at 60 Hz																																																																																								
PDD	VDD Power Consumption	4.65	5.58	7.36	[Watt]	VDD=5.0V, All white Pattern at 60 Hz																																																																																								
2.0 2016/3/21	25	3.5 Power ON/OFF Sequence <table border="1"> <thead> <tr> <th rowspan="2">Parameter</th> <th colspan="3">Value</th> <th rowspan="2">Unit</th> <th rowspan="2">Remark</th> </tr> <tr> <th>Min.</th> <th>Typ.</th> <th>Max.</th> </tr> </thead> <tbody> <tr> <td>T1</td> <td>0.5</td> <td>---</td> <td>10</td> <td>[ms]</td> <td></td> </tr> <tr> <td>T2</td> <td>0</td> <td>---</td> <td>50</td> <td>[ms]</td> <td></td> </tr> <tr> <td>T3</td> <td>500</td> <td>---</td> <td>---</td> <td>[ms]</td> <td></td> </tr> <tr> <td>T4</td> <td>100</td> <td>---</td> <td>---</td> <td>[ms]</td> <td></td> </tr> <tr> <td>T5</td> <td>0</td> <td>---</td> <td>50</td> <td>[ms]</td> <td>Note 3-5, Note 3-6</td> </tr> <tr> <td>T6</td> <td>5</td> <td>---</td> <td>100</td> <td>[ms]</td> <td>Note 3-5, Note 3-6</td> </tr> </tbody> </table>	Parameter	Value			Unit	Remark	Min.	Typ.	Max.	T1	0.5	---	10	[ms]		T2	0	---	50	[ms]		T3	500	---	---	[ms]		T4	100	---	---	[ms]		T5	0	---	50	[ms]	Note 3-5, Note 3-6	T6	5	---	100	[ms]	Note 3-5, Note 3-6	3.5 Power ON/OFF Sequence <table border="1"> <thead> <tr> <th rowspan="2">Symbol</th> <th colspan="3">Value</th> <th rowspan="2">Unit</th> <th rowspan="2">Remark</th> </tr> <tr> <th>Min.</th> <th>Typ.</th> <th>Max.</th> </tr> </thead> <tbody> <tr> <td>T1</td> <td>0.5</td> <td>---</td> <td>10</td> <td>[ms]</td> <td></td> </tr> <tr> <td>T2</td> <td>0</td> <td>---</td> <td>50</td> <td>[ms]</td> <td></td> </tr> <tr> <td>T3</td> <td>500</td> <td>---</td> <td>---</td> <td>[ms]</td> <td></td> </tr> <tr> <td>T4</td> <td>100</td> <td>---</td> <td>---</td> <td>[ms]</td> <td></td> </tr> <tr> <td>T5</td> <td>0</td> <td>---</td> <td>50</td> <td>[ms]</td> <td>Note 3-5, Note 3-6</td> </tr> <tr> <td>T6</td> <td>0</td> <td>---</td> <td>200</td> <td>[ms]</td> <td>Note 3-5, Note 3-6</td> </tr> </tbody> </table>	Symbol	Value			Unit	Remark	Min.	Typ.	Max.	T1	0.5	---	10	[ms]		T2	0	---	50	[ms]		T3	500	---	---	[ms]		T4	100	---	---	[ms]		T5	0	---	50	[ms]	Note 3-5, Note 3-6	T6	0	---	200	[ms]	Note 3-5, Note 3-6	
Parameter	Value			Unit	Remark																																																																																									
	Min.	Typ.	Max.																																																																																											
T1	0.5	---	10	[ms]																																																																																										
T2	0	---	50	[ms]																																																																																										
T3	500	---	---	[ms]																																																																																										
T4	100	---	---	[ms]																																																																																										
T5	0	---	50	[ms]	Note 3-5, Note 3-6																																																																																									
T6	5	---	100	[ms]	Note 3-5, Note 3-6																																																																																									
Symbol	Value			Unit	Remark																																																																																									
	Min.	Typ.	Max.																																																																																											
T1	0.5	---	10	[ms]																																																																																										
T2	0	---	50	[ms]																																																																																										
T3	500	---	---	[ms]																																																																																										
T4	100	---	---	[ms]																																																																																										
T5	0	---	50	[ms]	Note 3-5, Note 3-6																																																																																									
T6	0	---	200	[ms]	Note 3-5, Note 3-6																																																																																									
	26	4.1 Block Diagram <p>The following shows the block diagram of the 27 inch Backlight Unit. And it includes 40 pcs LED in the LED light bar. (4 strings and 10 pcs LED of one string).</p>	4.1 Block Diagram <p>The following shows the block diagram of the 27 inch Backlight Unit. And it includes 60 pcs LED in the LED light bar. (4 strings and 15 pcs LED of one string).</p>																																																																																											
	29	4.3.2 Recommended Operating Condition <table border="1"> <thead> <tr> <th>Symbol</th> <th>Description</th> <th>Min.</th> <th>Typ.</th> <th>Max.</th> <th>Unit</th> <th>Remark</th> </tr> </thead> <tbody> <tr> <td>IFLED</td> <td>LED Forward Current</td> <td>115</td> <td>115.5</td> <td>---</td> <td>[mA]</td> <td>Note 4-1</td> </tr> <tr> <td>VSLED</td> <td>Light Bar Operation Voltage (for reference)</td> <td>44.25</td> <td>49.5</td> <td>54</td> <td>[VOLT]</td> <td>Note 4-2</td> </tr> <tr> <td>PBLU</td> <td>BLU Power Consumption (for reference)</td> <td>21.76</td> <td>23.76</td> <td>---</td> <td>[Watt]</td> <td>Note 4-3</td> </tr> </tbody> </table> <p>Note 4: Definition of life time: Brightness becomes to 50% of its original value.</p>	Symbol	Description	Min.	Typ.	Max.	Unit	Remark	IFLED	LED Forward Current	115	115.5	---	[mA]	Note 4-1	VSLED	Light Bar Operation Voltage (for reference)	44.25	49.5	54	[VOLT]	Note 4-2	PBLU	BLU Power Consumption (for reference)	21.76	23.76	---	[Watt]	Note 4-3	4.3.2 Recommended Operating Condition <table border="1"> <thead> <tr> <th>Symbol</th> <th>Description</th> <th>Min.</th> <th>Typ.</th> <th>Max.</th> <th>Unit</th> <th>Remark</th> </tr> </thead> <tbody> <tr> <td>IF</td> <td>LED String Current</td> <td>---</td> <td>80</td> <td>84</td> <td>[mA]</td> <td>100% duty ratio of LED chip, Note 4-2</td> </tr> <tr> <td>VF</td> <td>LED String Voltage</td> <td>43.5</td> <td>46.5</td> <td>51</td> <td>[VOLT]</td> <td>IF=80mA @ 100% duty ratio, Note 4-1, Note 4-5</td> </tr> <tr> <td>ΔVF</td> <td>Maximum V_F Voltage Deviation of light bar</td> <td>---</td> <td>---</td> <td>3</td> <td>[VOLT]</td> <td>IF=80mA @ 100% duty ratio, Note 4-2</td> </tr> <tr> <td>PBLU</td> <td>LED Light Bar Power Consumption</td> <td>---</td> <td>14.88</td> <td>16.32</td> <td>[Watt]</td> <td>Note 4-3</td> </tr> </tbody> </table> <p>Note 4-1: a. VF: LED chip forward voltage, VF (Min.)=2.8V, VF (Typ.)=3.1V,</p>	Symbol	Description	Min.	Typ.	Max.	Unit	Remark	IF	LED String Current	---	80	84	[mA]	100% duty ratio of LED chip, Note 4-2	VF	LED String Voltage	43.5	46.5	51	[VOLT]	IF=80mA @ 100% duty ratio, Note 4-1, Note 4-5	ΔVF	Maximum V _F Voltage Deviation of light bar	---	---	3	[VOLT]	IF=80mA @ 100% duty ratio, Note 4-2	PBLU	LED Light Bar Power Consumption	---	14.88	16.32	[Watt]	Note 4-3																												
Symbol	Description	Min.	Typ.	Max.	Unit	Remark																																																																																								
IFLED	LED Forward Current	115	115.5	---	[mA]	Note 4-1																																																																																								
VSLED	Light Bar Operation Voltage (for reference)	44.25	49.5	54	[VOLT]	Note 4-2																																																																																								
PBLU	BLU Power Consumption (for reference)	21.76	23.76	---	[Watt]	Note 4-3																																																																																								
Symbol	Description	Min.	Typ.	Max.	Unit	Remark																																																																																								
IF	LED String Current	---	80	84	[mA]	100% duty ratio of LED chip, Note 4-2																																																																																								
VF	LED String Voltage	43.5	46.5	51	[VOLT]	IF=80mA @ 100% duty ratio, Note 4-1, Note 4-5																																																																																								
ΔVF	Maximum V _F Voltage Deviation of light bar	---	---	3	[VOLT]	IF=80mA @ 100% duty ratio, Note 4-2																																																																																								
PBLU	LED Light Bar Power Consumption	---	14.88	16.32	[Watt]	Note 4-3																																																																																								

	<p>The minimum life time of LED unit is on the condition of IFLED = 110mA and 25±2°C (Room Temperature).</p>	<p>$V_F(\text{Max.})=3.4V$ <i>Note 4-4: Definition of life time:</i> <i>a. Brightness of LED becomes to 50% of its original value</i> <i>b. Test condition: $I_s = 80mA$ and $25^\circ C$ (Room Temperature)</i></p>	
--	--	--	--

SPLCD.com
 Supply & Purchase Cloud Platform



1 Handling Precautions

- 1) Since polarizer is easily damaged, do not touch or press the surface of polarizer with hand.
- 2) Be sure to turn off power supply when inserting or disconnecting from input connector.
- 3) Wipe off water drop immediately. Long contact with water may cause discoloration or spots.
- 4) When the panel surface is soiled, wipe it with absorbent cotton or other soft cloth.
- 5) Since the panel is made of glass, it may break or crack if dropped or bumped on hard surface.
- 6) Since CMOS LSI is used in this module, take care of static electricity and insure human earth when handling.
- 7) Do not open or modify the Module Assembly.
- 8) Do not press the reflector sheet at the back of the module to any directions.
- 9) In case a TFT-LCD Module has to be put back into the packing container slot after once it was taken out from the container, do not press the center of the LED lightbar edge. Otherwise the TFT-LCD Module may be damaged.
- 10) Insert or pull out the interface connector, be sure not to rotate nor tilt it of the TFT-LCD Module.
- 11) Do not twist nor bend the TFT-LCD Module even momentary. It should be taken into consideration that no bending/twisting forces are applied to the TFT-LCD Module from outside. Otherwise the TFT-LCD Module may be damaged.
- 12) Please avoid touching COF position while you are doing mechanical design.
- 13) When storing modules as spares for a long time, the following precaution is necessary:
Store them in a dark place. Do not expose the module to sunlight or fluorescent light.
Keep the temperature between 5°C and 35°C at normal humidity.
- 14) Do not apply the same pattern for a long time, it will enhance relevant defect.

2 General Description

This specification applies to the 27 inch-FHD color α -Si TFT-LCD Module M270HVN02.0. The display supports the FHD - 1920(H) x 1080(V) screen format and 16.7M colors (RGB 8-bit data input). The light source of this TFT-LCD module is W-LED. All input signals are 2-channel LVDS interface and this module doesn't contain a driver for backlight.

2.1 Display Characteristics

The following items are characteristics summary on the table under 25°C condition:

Items	Unit	Specification
Screen Diagonal	[mm]	685.65(27.0")
Active Area	[mm]	597.6 (H) x 336.15 (V)
Pixels H x V	-	1920(x3) x 1080
Pixel Pitch	[μ m]	311.25 (per one triad) x 311.25
Pixel Arrangement	-	R.G.B. Vertical island
Display Mode	-	VA Mode, Normally Black
White Luminance (Center)	[cd/m^2]	300 cd/m^2 (Typ.)
Contrast Ratio	-	3000 (Typ.)
Optical Response Time	[msec]	12ms (Typ., on/off)
Nominal Input Voltage VDD	[Volt]	5 V (Typ)
Power Consumption (VDD line + LED line)	[Watt]	19.53 watt VDD line : PDD (typ), All white pattern at 60Hz = 4.65 W LED line : PBLU (typ) = 14.88 W(@80mA)
Weight	[Grams]	2180
Physical Size	[mm]	613.6(H)x356.85(V)x10.0(D) Typ.
Electrical Interface	-	Dual channel LVDS
Support Color	-	16.7M colors (RGB 8-bit)
Surface Treatment	-	Anti-Glare 3H
Temperature Range		
Operating	[°C]	0 to +50
Storage (Shipping)	[°C]	-20 to +60

RoHS Compliance		RoHS Compliance
TCO Compliance		TCO 7.0 Compliance

2.2 Absolute Ratings of Environment

Permanent damage may occur if exceeding the following maximum rating.

Symbol	Description	Min.	Max.	Unit	Remark
TOP	Operating Temperature	0	+50	[°C]	Note 2-1
TGS	Glass surface temperature (operation)	0	+65	[°C]	Note 2-1 Function judged only
HOP	Operation Humidity	5	90	[%RH]	Note 2-1
TST	Storage Temperature	-20	+60	[°C]	
HST	Storage Humidity	5	90	[%RH]	

Note 2-1: Temperature and relative humidity range are shown as the below figure.

1. 90% RH Max ($T_a \leq 39^\circ\text{C}$)
2. Max wet-bulb temperature at 39°C or less. ($T_a \leq 39^\circ\text{C}$)
3. No condensation

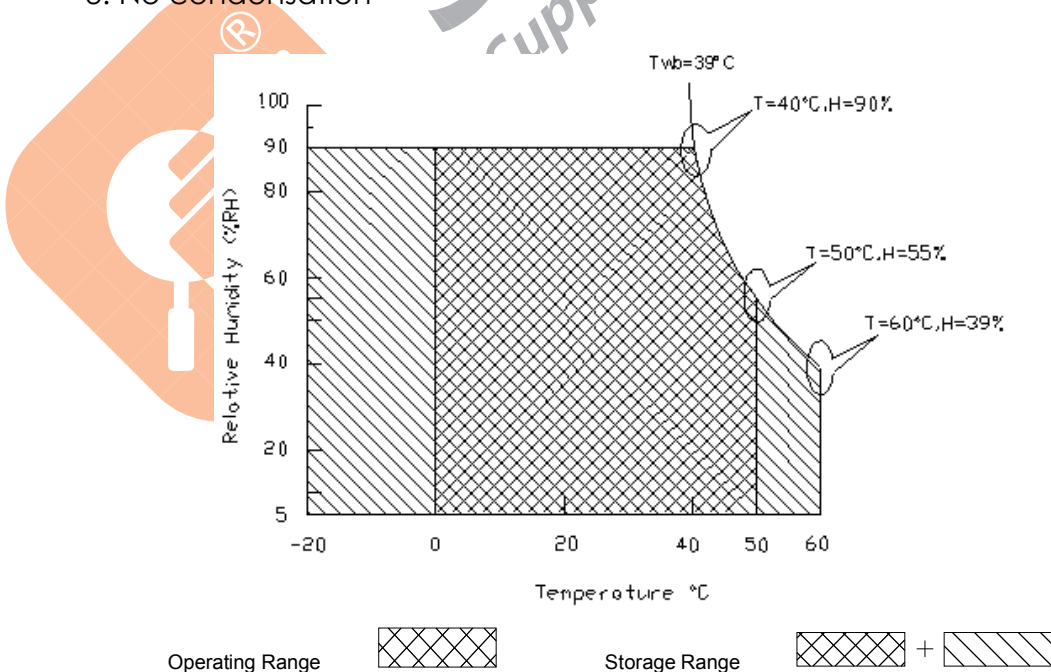

2.3 Optical Characteristics

The optical characteristics are measured on the following test condition.

Test Condition:

1. Equipment setup: Please refer to **Note 2-2**.
2. Panel Lighting time: 30 minutes
3. VDD=5V, Fv=60Hz, Is=80mA, Ta=25°C

Symbol	Description		Min.	Typ.	Max.	Unit	Remark
L _w	White Luminance (Center of screen)		240	300	-	[cd/m ²]	Note 2-2 By SR-3
L _{uni}	Luminance Uniformity (9 points)		75	80	-	[%]	Note 2-3 By SR-3
CR	Contrast Ratio (Center of screen)		1800	3000	-	-	Note 2-4 By SR-3
θ _R	Horizontal Viewing Angle (CR=10)	Right	75	89	-	[degree]	Note 2-5 By SR-3
θ _L		Left	75	89	-		
Φ _H	Vertical Viewing Angle (CR=10)	Up	75	89	-		
Φ _L		Down	75	89	-		
T _{rR}	Response Time	Raising Time	-	7	17	[msec]	Note 2-6 By TRD-100
T _{rF}		Falling Time		5	7		
T _{rR} + T _{rF}		Raising + Falling		12	24		
R _x	Color Coordinates (CIE 1931)	Red x	0.610	0.640	0.670	-	By SR-3
R _y		Red y	0.303	0.333	0.363		
G _x		Green x	0.290	0.320	0.350		
G _y		Green y	0.590	0.620	0.650		
B _x		Blue x	0.126	0.156	0.186		
B _y		Blue y	0.025	0.055	0.085		
W _x		White x	0.283	0.313	0.343		
W _y		White y	0.299	0.329	0.359		
CT	Crosstalk		-	-	1.5	[%]	Note 2-7 By SR-3

F _{dB}	Flicker (Center of screen)	-	-	-20	[dB]	Note 2-8 By SR-3
-----------------	----------------------------	---	---	-----	------	----------------------------

Note 2-2: Equipment setup :

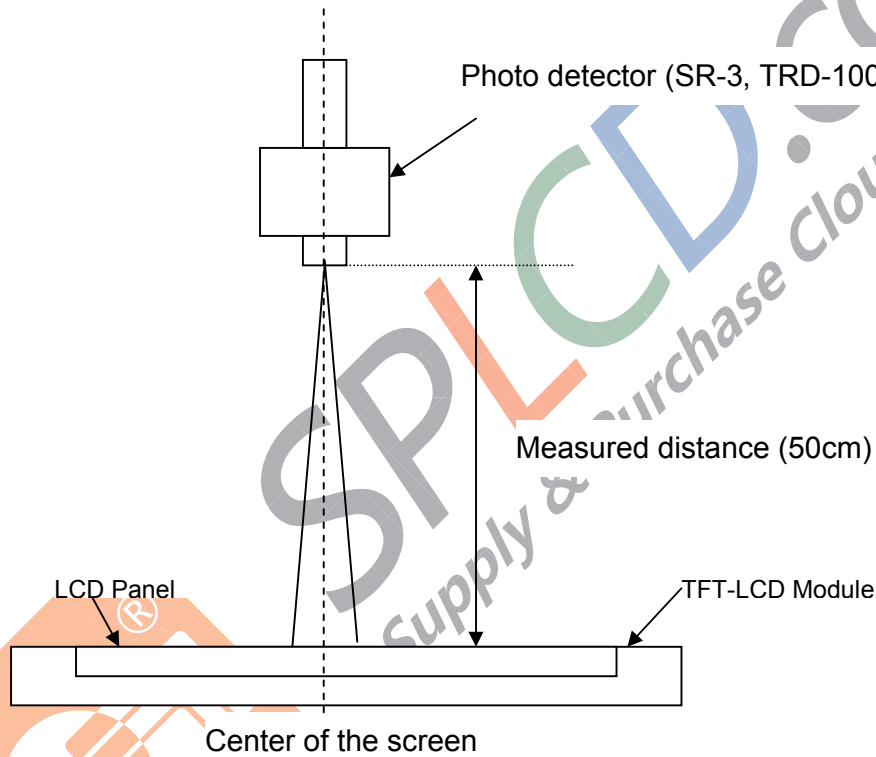

Note 2-3: Luminance Uniformity Measurement

Definition:

$$\text{Luminance Uniformity} = \frac{\text{Minimum Luminance of 9 Points (P1 ~ P9)}}{\text{Maximum Luminance of 9 Points (P1 ~ P9)}}$$

a. Test pattern: White Pattern

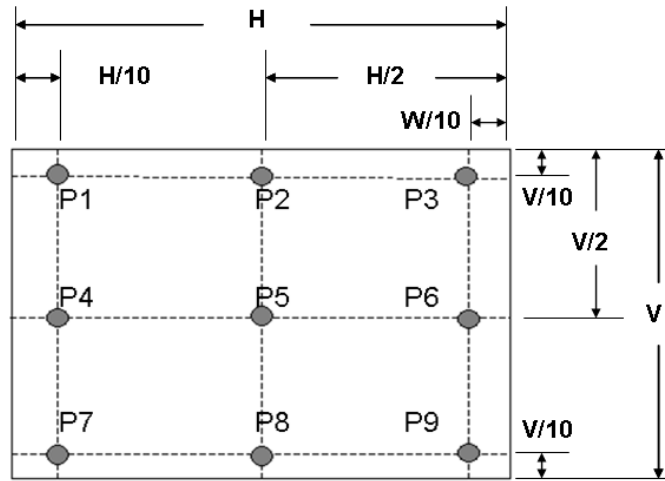

Note 2-4: Contrast Ratio Measurement

Definition:

$$\text{Contrast Ratio} = \frac{\text{Luminance of White pattern}}{\text{Luminance of Black pattern}}$$

a. Measured position: Center of screen (P5) & perpendicular to the screen ($\theta = \Phi = 0^\circ$)

Note 2-5: Viewing angle measurement

Definition: The angle at which the contrast ratio is greater than 10 & 5 .

- a. Horizontal view angle: Divide to left & right (θ_L & θ_R)
- Vertical view angle: Divide to up & down (Φ_H & Φ_L)

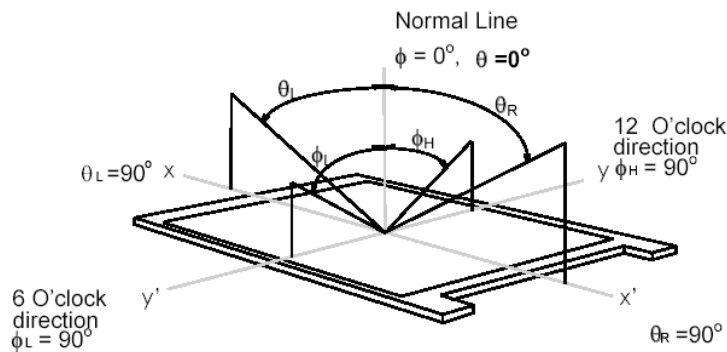

Note 2-6: Response time measurement

The output signals of photo detector are measured when the input signals are changed from “Full Black” to “Full White” (rising time, T_{rR}), and from “Full White” to “Full Black” (falling time, T_{rF}), respectively. The response time is interval between the 10% and 90% (1 frame at 60 Hz) of amplitudes.

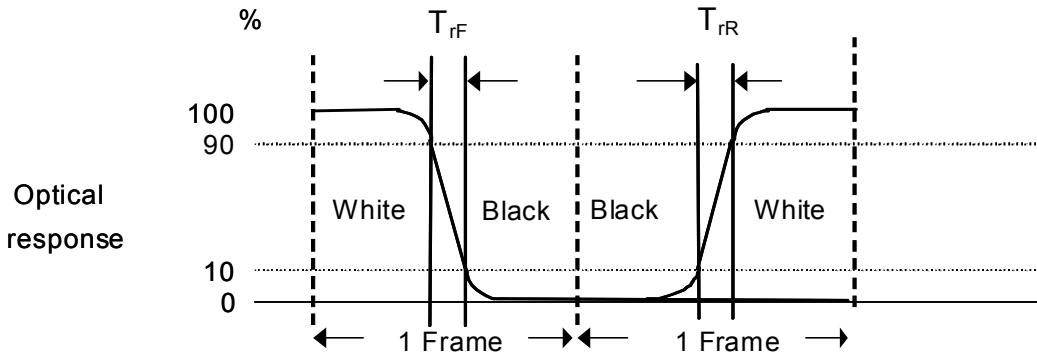

$T_{rR} + T_{rF} = 12 \text{ msec (typ.)}$.

Note 2-7: Crosstalk measurement

Definition:

$$CT = \text{Max. } (CT_H, CT_V);$$

Where

a. Maximum Horizontal Crosstalk :

$$CT_H = \text{Max. } (| Y_{BL} - Y_{AL} | / Y_{AL} \times 100 \%, | Y_{BR} - Y_{AR} | / Y_{AR} \times 100 \%);$$

Maximum Vertical Crosstalk:

$$CT_V = \text{Max. } (| Y_{BU} - Y_{AU} | / Y_{AU} \times 100 \%, | Y_{BD} - Y_{AD} | / Y_{AD} \times 100 \%);$$

b. $Y_{AU}, Y_{AD}, Y_{AL}, Y_{AR}$ = Luminance of measured location without Black pattern

$Y_{BU}, Y_{BD}, Y_{BL}, Y_{BR}$ = Luminance of measured location with Black pattern

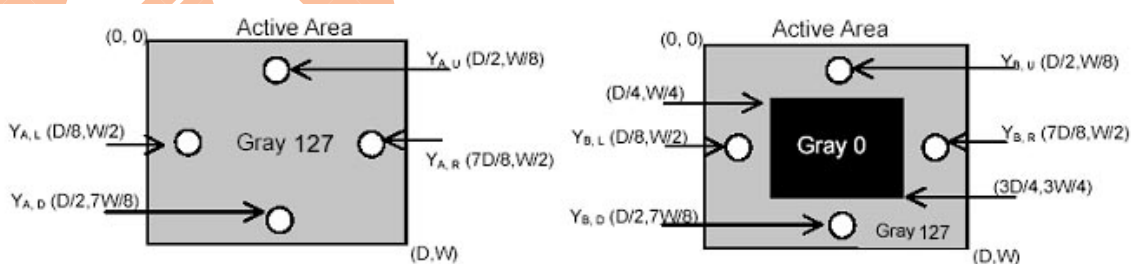

Note 2-8: Flicker measurement

a. Test pattern: It is listed as following.

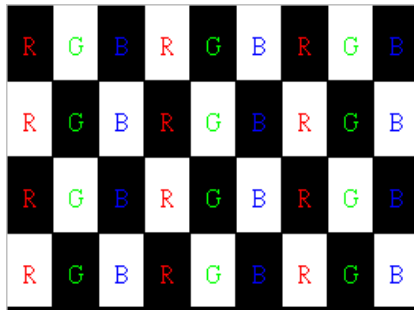

Gray level = L0



Gray level = L127

R: Red, G: Green, B:Blue

b. Measured position: Center of screen (P5) & perpendicular to the screen
($\theta = \Phi = 0^\circ$)

2.4 Mechanical Characteristics

Symbol	Description	Min.	Max.	Unit	Remark
P _{bc}	Backside Compression	2.5	-	[Kgf]	Note 2-9

Note 2-9: Test Method:

The point is at a distance from right-downside 25mm x 25mm defined as the Start Point of Measure Points, and the point is at a distance 25mm from left-side & around 10mm from PCB defined as the End Point.

Align 50mm x 50mm block from Start Point on the Bezel Back, and the corners of each block are Measure Points.

If the distance from the last block to each side of the End Point ≥ 25 mm, add other blocks to make sure that most area of Bezel Back can be measured.

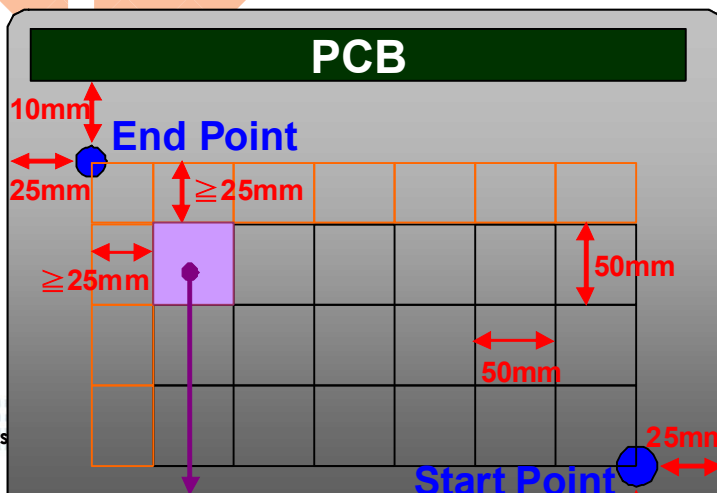

SPLCD.com
Supply & Purchase Cloud Platform

3 TFT-LCD Module

3.1 Block Diagram

The following shows the block diagram of the 27 inch Color TFT-LCD Module.

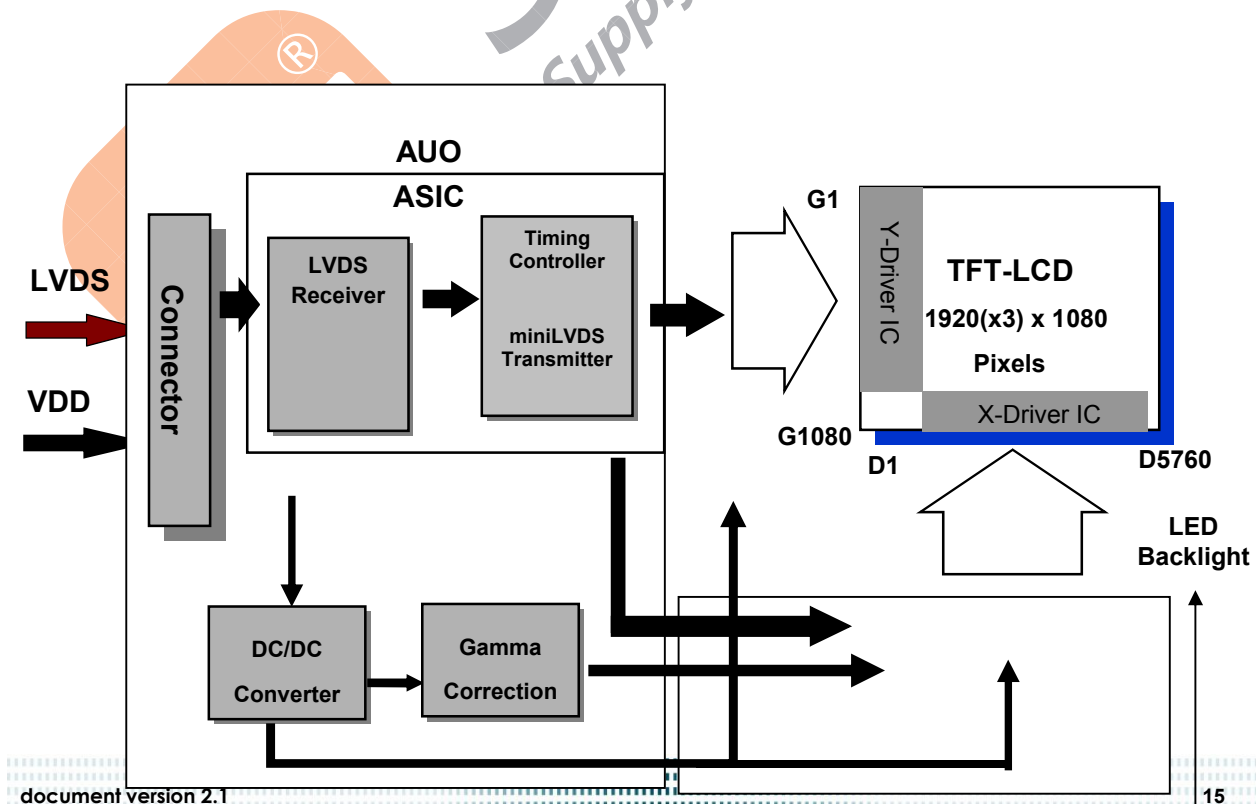

I/F + X-PCB

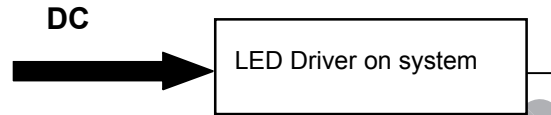

3.2 Interface Connection

3.2.1 Connector Type

TFT-LCD Connector	Manufacturer	P-TWO	STM	STARCONN
	Part Number	AL230F-A0G1D-P	MSCKT2407P30HB	093G30-02001A-M4
Mating Connector	Manufacturer	JAE or Compatible		
	Part Number	FI-X30HL (Locked Type)		

3.2.2 Connector Pin Assignment

PIN #	SIGNAL NAME	DESCRIPTION
1	RX00-	Negative LVDS differential data input (Odd data)
2	RX00+	Positive LVDS differential data input (Odd data)
3	RX01-	Negative LVDS differential data input (Odd data)
4	RX01+	Positive LVDS differential data input (Odd data)
5	RX02-	Negative LVDS differential data input (Odd data, H-Sync,V-Sync,DSPTMG)
6	RX02+	Positive LVDS differential data input (Odd data, H-Sync,V-Sync,DSPTMG)
7	GND	Power Ground
8	RXOCLK-	Negative LVDS differential clock input (Odd clock)
9	RXOCLK+	Positive LVDS differential clock input (Odd clock)
10	RX03-	Negative LVDS differential data input (Odd data)
11	RX03+	Positive LVDS differential data input (Odd data)

12	RXE0-	Negative LVDS differential data input (Even data)
13	RXE0+	Positive LVDS differential data input (Even data)
14	GND	Power Ground
15	RXE1-	Negative LVDS differential data input (Even data)
16	RXE1+	Positive LVDS differential data input (Even data)
17	GND	Power Ground
18	RXE2-	Negative LVDS differential data input (Even data)
19	RXE2+	Positive LVDS differential data input (Even data)
20	RXECLK-	Negative LVDS differential clock input (Even clock)
21	RXECLK+	Positive LVDS differential clock input (Even clock)
22	RXE3-	Negative LVDS differential data input (Even data)
23	RXE3+	Positive LVDS differential data input (Even data)
24	GND	Power Ground
25	NC	No contact
26	NC	No contact
27	NC	No contact
28	VDD	+5.0V Power Supply
29	VDD	+5.0V Power Supply
30	VDD	+5.0V Power Supply

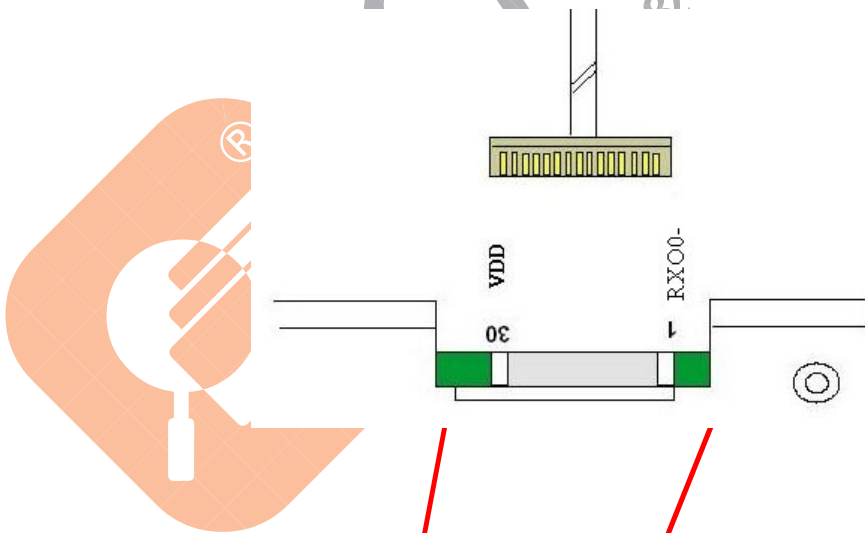

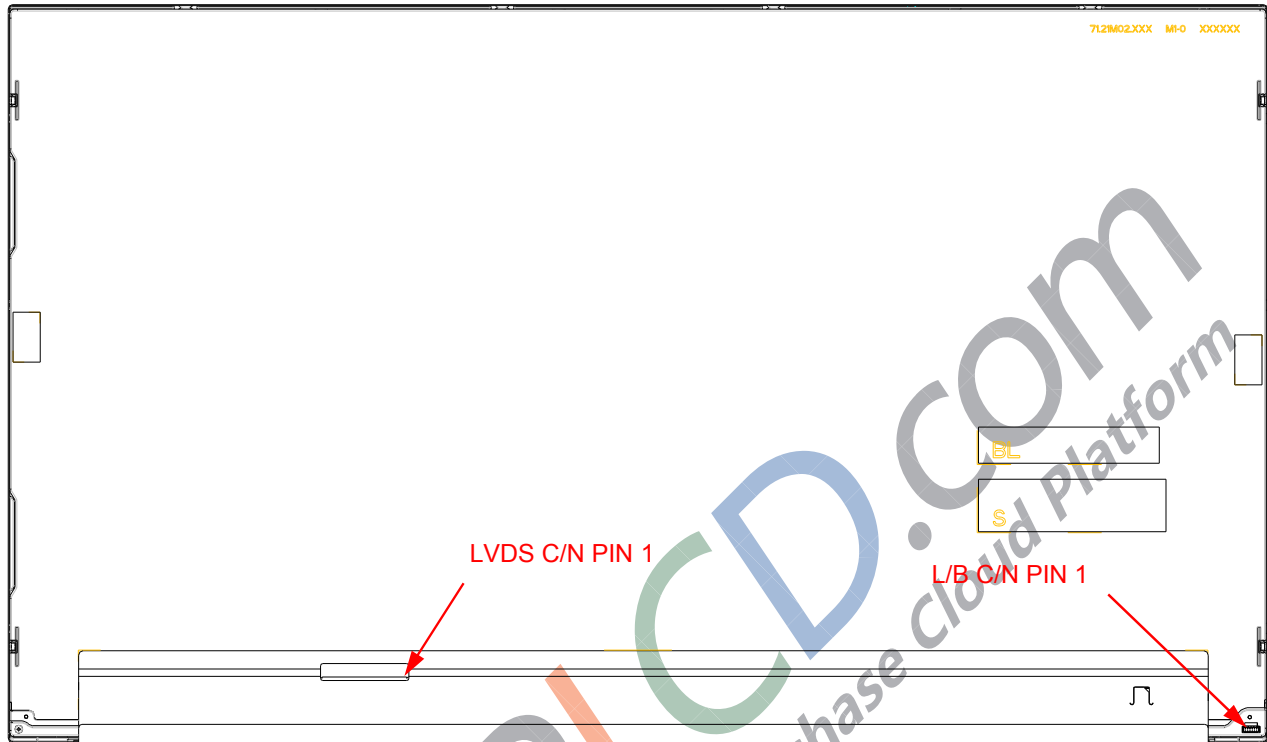

3.3 Electrical Characteristics

3.3.1 Absolute Maximum Rating

Permanent damage may occur if exceeding the following maximum rating.

Symbol	Description	Min	Max	Unit	Remark
VDD	Power Supply Input Voltage	GND-0.3	6.0	[Volt]	Ta=25°C

3.3.2 Recommended Operating Condition

Symbol	Description	Min	Typ	Max	Unit	Remark
VDD	Power supply Input voltage	4.5	5.0	5.5	[Volt]	
IDD	Power supply Input Current (RMS)	-	0.93	1.22	[A]	VDD= 5.0V, All white Pattern at 60 Hz
		-	1.22	1.46	[A]	VDD= 5.0V, All white Pattern at 75 Hz
PDD	VDD Power Consumption	-	4.65	5.58	[Watt]	VDD= 5.0V, All white Pattern at 60 Hz
		-	6.10	7.30	[Watt]	VDD= 5.0V, All white Pattern at 75 Hz
IRush	Inrush Current	-	-	3.0	[A]	Note 3-1
VDDrp	Allowable VDD Ripple Voltage	-	-	500	[mV]	VDD= 5.0V, All white Pattern at 75 Hz

Note 3-1: Inrush Current measurement:

Test circuit:

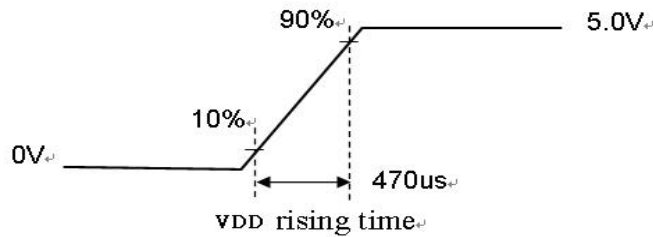
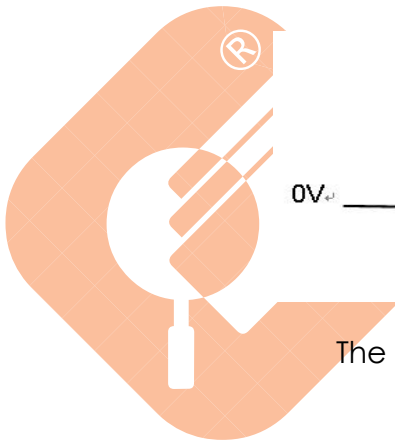
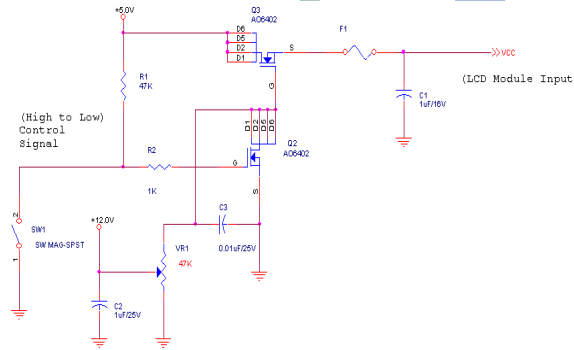

The duration of VDD rising time: 470µs.

3.4 Signal Characteristics

3.4.1 LCD Pixel Format

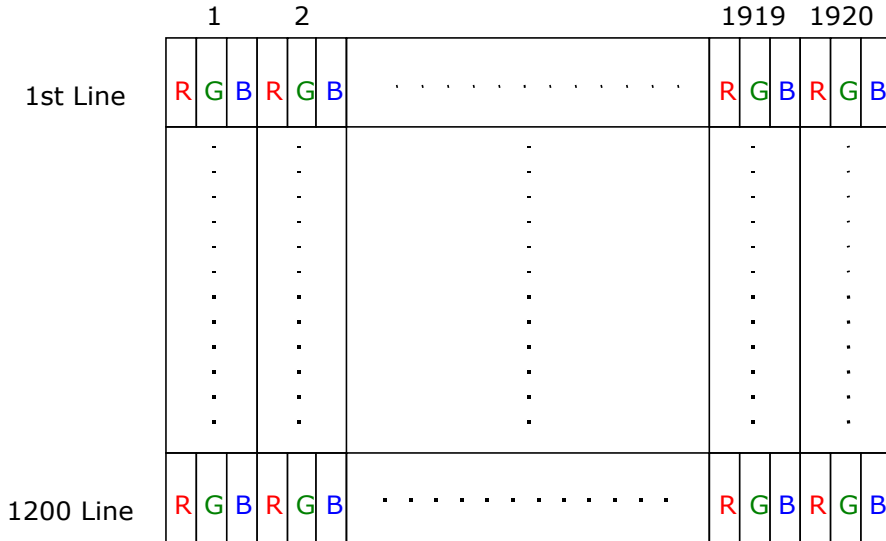

3.4.2 LVDS Data Format

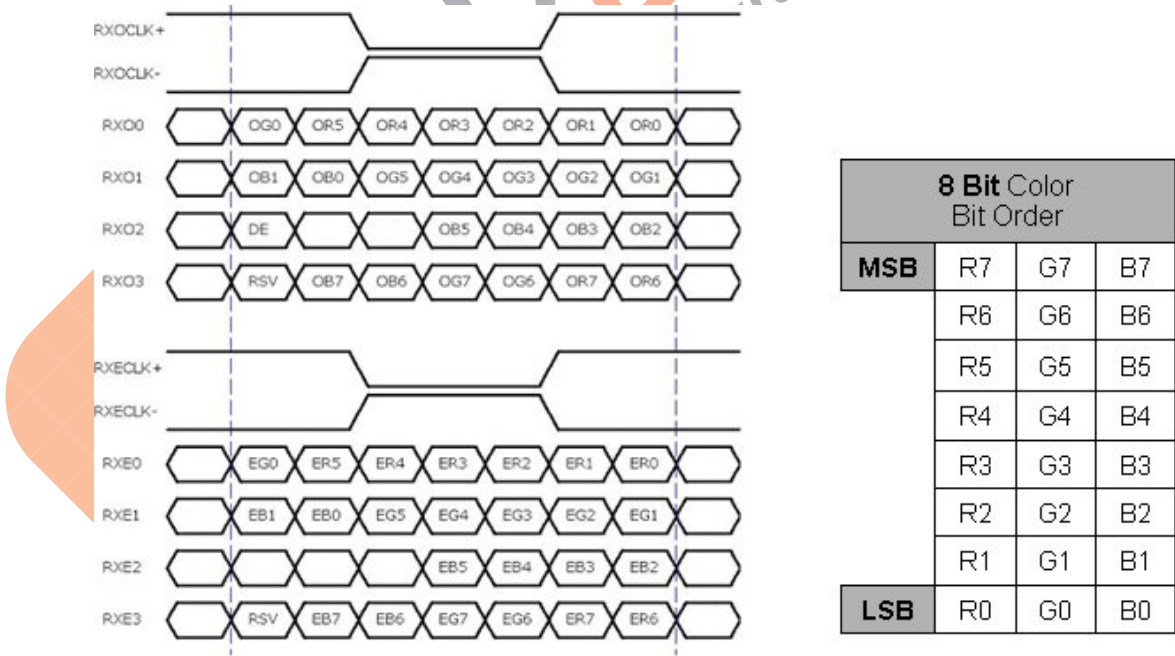

Note 3-2:

- a. O = "Odd Pixel Data" E = "Even Pixel Data"
- b. Refer to 3.4.1 LCD pixel format, the 1st data is 1 (Odd Pixel Data), the 2nd data is 2 (Even Pixel Data) and the last data is 1920 (Even Pixel Data).

3.4.3 Color versus Input Data

The following table is for color versus input data (8bit). The higher the gray level, the brighter the color.

Color	Gray Level	Color Input Data																								Remark
		RED data (MSB:R7, LSB:R0)								GREEN data (MSB:G7, LSB:G0)								BLUE data (MSB:B7, LSB:B0)								
		R7	R6	R5	R4	R3	R2	R1	R0	G7	G6	G5	G4	G3	G2	G1	G0	B7	B6	B5	B4	B3	B2	B1	B0	
Black	-	0	0	0	0	0	0	0	0	0	0	0	0	0	0	0	0	0	0	0	0	0	0	0	0	
White	-	1	1	1	1	1	1	1	1	1	1	1	1	1	1	1	1	1	1	1	1	1	1	1	1	
Gray 127	-	0	1	1	1	1	1	1	1	0	1	1	1	1	1	1	1	0	1	1	1	1	1	1	1	
Red	L0	0	0	0	0	0	0	0	0	0	0	0	0	0	0	0	0	0	0	0	0	0	0	0	0	Black
	:	:	:	:	:	:	:	:	:	:	:	:	:	:	:	:	:	:	:	:	:	:	:	:	:	
	L255	1	1	1	1	1	1	1	1	0	0	0	0	0	0	0	0	0	0	0	0	0	0	0	0	
Green	L0	0	0	0	0	0	0	0	0	0	0	0	0	0	0	0	0	0	0	0	0	0	0	0	0	Black
	:	:	:	:	:	:	:	:	:	:	:	:	:	:	:	:	:	:	:	:	:	:	:	:	:	
	L255	0	0	0	0	0	0	0	0	1	1	1	1	1	1	1	1	0	0	0	0	0	0	0	0	
Blue	L0	0	0	0	0	0	0	0	0	0	0	0	0	0	0	0	0	0	0	0	0	0	0	0	0	Black
	:	:	:	:	:	:	:	:	:	:	:	:	:	:	:	:	:	:	:	:	:	:	:	:	:	
	L255	0	0	0	0	0	0	0	0	0	0	0	0	0	0	0	0	1	1	1	1	1	1	1	1	

3.4.4 LVDS Specification

a. DC Characteristics:

Symbol	Description	Min	Typ	Max	Units	Condition
V_{TH}	LVDS Differential Input High Threshold	-	-	+100	[mV]	$V_{CM} = 1.2V$
V_{TL}	LVDS Differential Input Low Threshold	-100	-	-	[mV]	$V_{CM} = 1.2V$
$ V_{ID} $	LVDS Differential Input Voltage	100	-	600	[mV]	
V_{CM}	LVDS Common Mode Voltage	+1.0	+1.2	+1.5	[V]	$V_{TH}-V_{TL} = 200mV$

LVDS Signal Waveform:

Use RxOCLK- & RxOCLK+ as example.

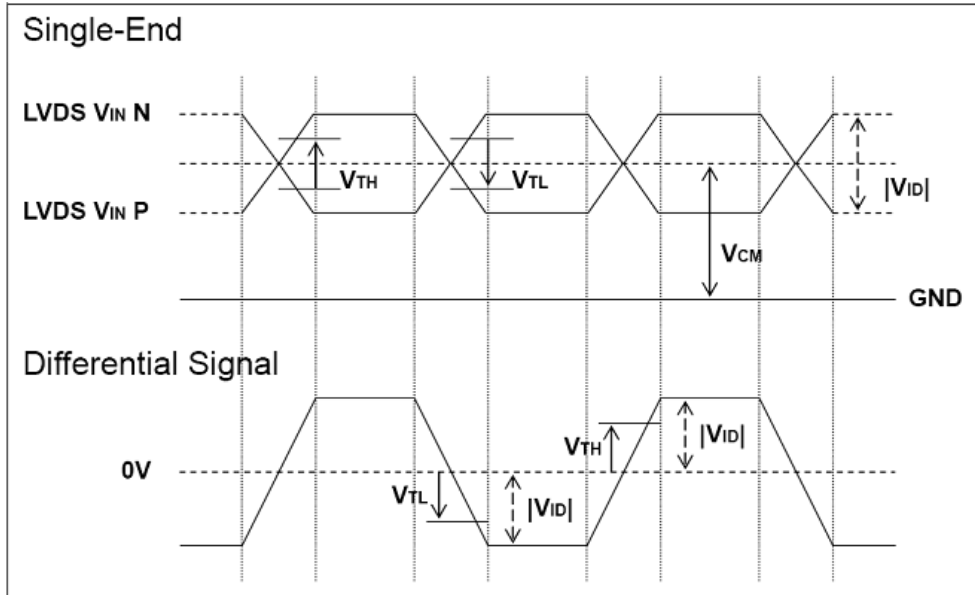

b. AC Characteristics:

Symbol	Description	Min	Max	Unit	Remark
F _{DEV}	Maximum deviation of input clock frequency during Spread Spectrum	-	± 3	%	
F _{MOD}	Maximum modulation frequency of input clock during Spread Spectrum	-	200	KHz	

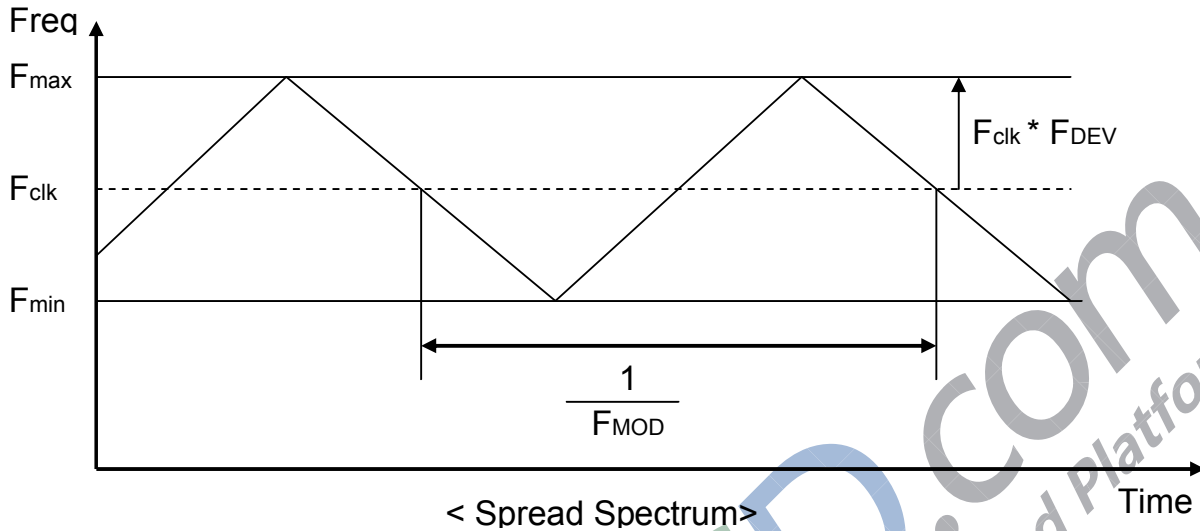

F_{clk}: LVDS Clock Frequency

3.4.5 Input Timing Specification

If only support DE mode, and the input timing are shown as the following table.

Symbol	Description	Min.	Typ.	Max.	Unit	Remark	
T _v	Vertical Section	Period	1092	1130	1793	Th	
T _{disp (v)}		Active	1080	1080	1080	Th	
T _{blk (v)}		Blanking	12	50	713	Th	
F _v		Frequency	50	60	76	Hz	
T _h	Horizontal Section	Period	1004	1050	1100	T _{clk}	
T _{disp (h)}		Active	960	960	960	T _{clk}	
T _{blk (h)}		Blanking	44	90	140	T _{clk}	
F _h		Frequency	55	68	90	KHz	Note 3-3
T _{clk}	LVDS Clock	Period	11.1	14.0	18.2	ns	1/F _{clk}
F _{clk}		Frequency	54.8	71.2	90.0	MHz	Note 3-4

Note 3-3: The equation is listed as following. Please don't exceed the above recommended value.

$$F_h (\text{Min.}) = F_{\text{clk}} (\text{Min.}) / T_h (\text{Min.});$$

$$F_h (\text{Typ.}) = F_{\text{clk}} (\text{Typ.}) / T_h (\text{Typ.});$$

$$F_h (\text{Max.}) = F_{clk} (\text{Max.}) / T_h (\text{Min.});$$

Note 3-4: The equation is listed as following. Please don't exceed the above recommended value.

$$F_{clk} (\text{Min.}) = F_v (\text{Min.}) \times T_h (\text{Min.}) \times T_v (\text{Min.});$$

$$F_{clk} (\text{Typ.}) = F_v (\text{Typ.}) \times T_h (\text{Typ.}) \times T_v (\text{Typ.});$$

$$F_{clk} (\text{Max.}) = F_v (\text{Max.}) \times T_h (\text{Typ.}) \times T_v (\text{Typ.});$$

3.4.6 Input Timing Diagram

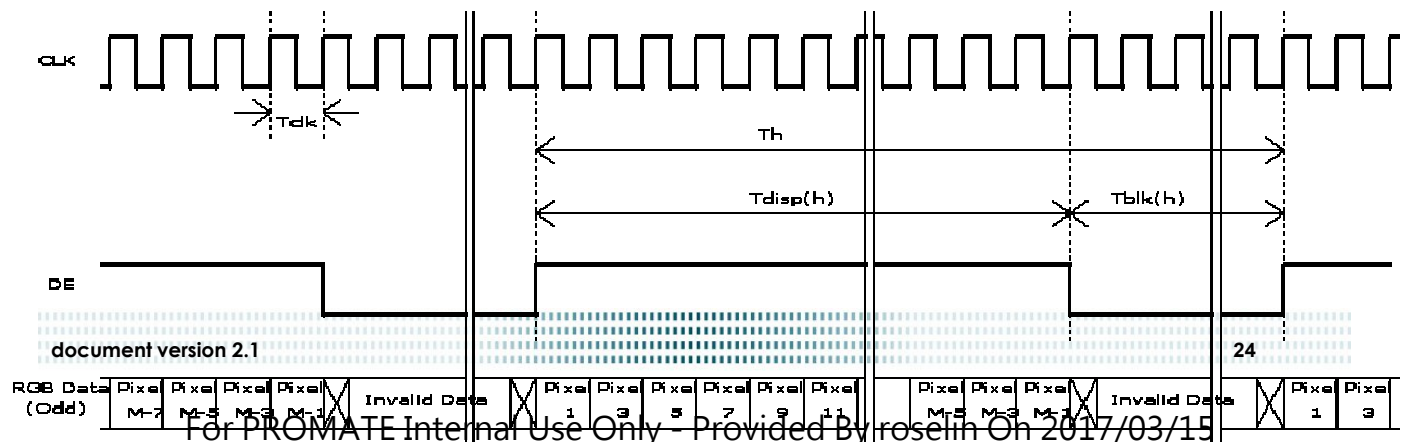
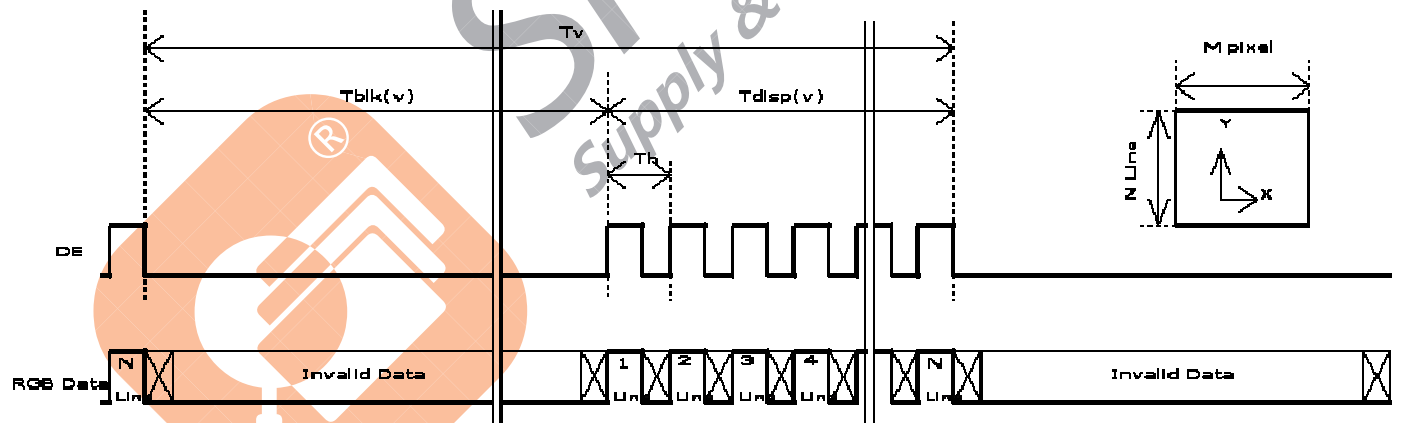

SPLCD.com
 Supply & Purchase Cloud Platform

3.5 Power ON/OFF Sequence

VDD power, LVDS signal and backlight on/off sequence are as following. LVDS signals from any system shall be Hi-Z state when VDD is off.

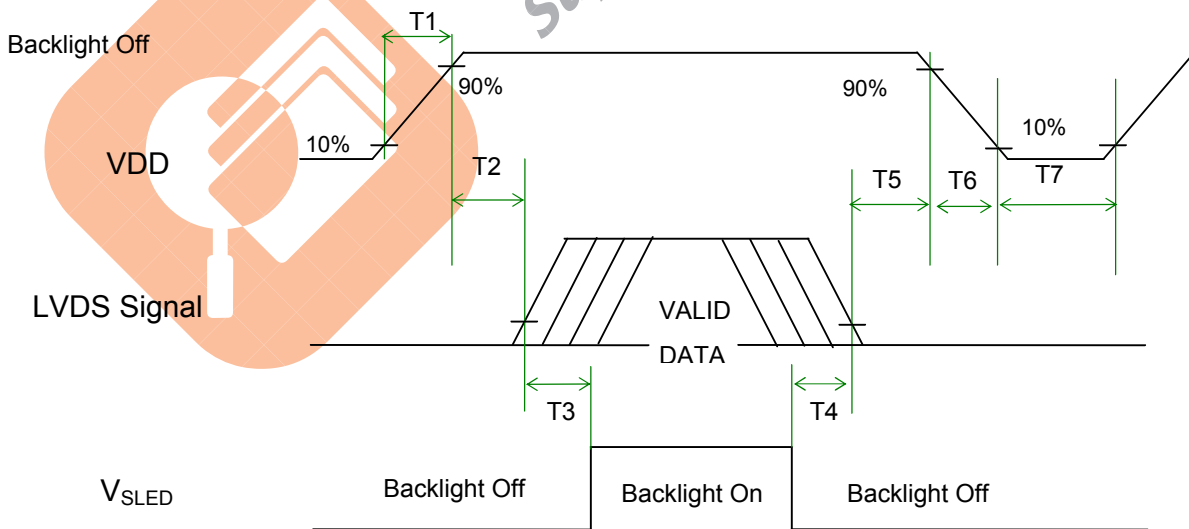

Power Sequence Timing

Symbol	Value			Unit	Remark
	Min.	Typ.	Max.		
T1	0.5	-	10	[ms]	
T2	0	-	50	[ms]	
T3	500	-	-	[ms]	
T4	100	-	-	[ms]	
T5	0		50	[ms]	Note 3-5 Note 3-6
T6	0	-	200	[ms]	Note 3-6 Note 3-7
T7	1000	-	-	[ms]	

Note 3-5 : Recommend setting T5 = 0ms to avoid electronic noise when VDD is off.

Note 3-6 : During T5 and T6 period , please keep the level of input LVDS signals with Hi-Z state.

Note 3-7 : Voltage of VDD must decay smoothly after power-off. (customer system decide this value)

4 Backlight Unit

4.1 Block Diagram

The following shows the block diagram of the 27 inch Backlight Unit. And it includes 60pcs LED in the LED light bar. (4 strings and 15 pcs LED of one string).

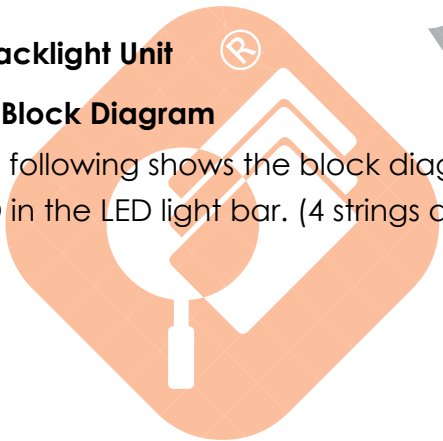

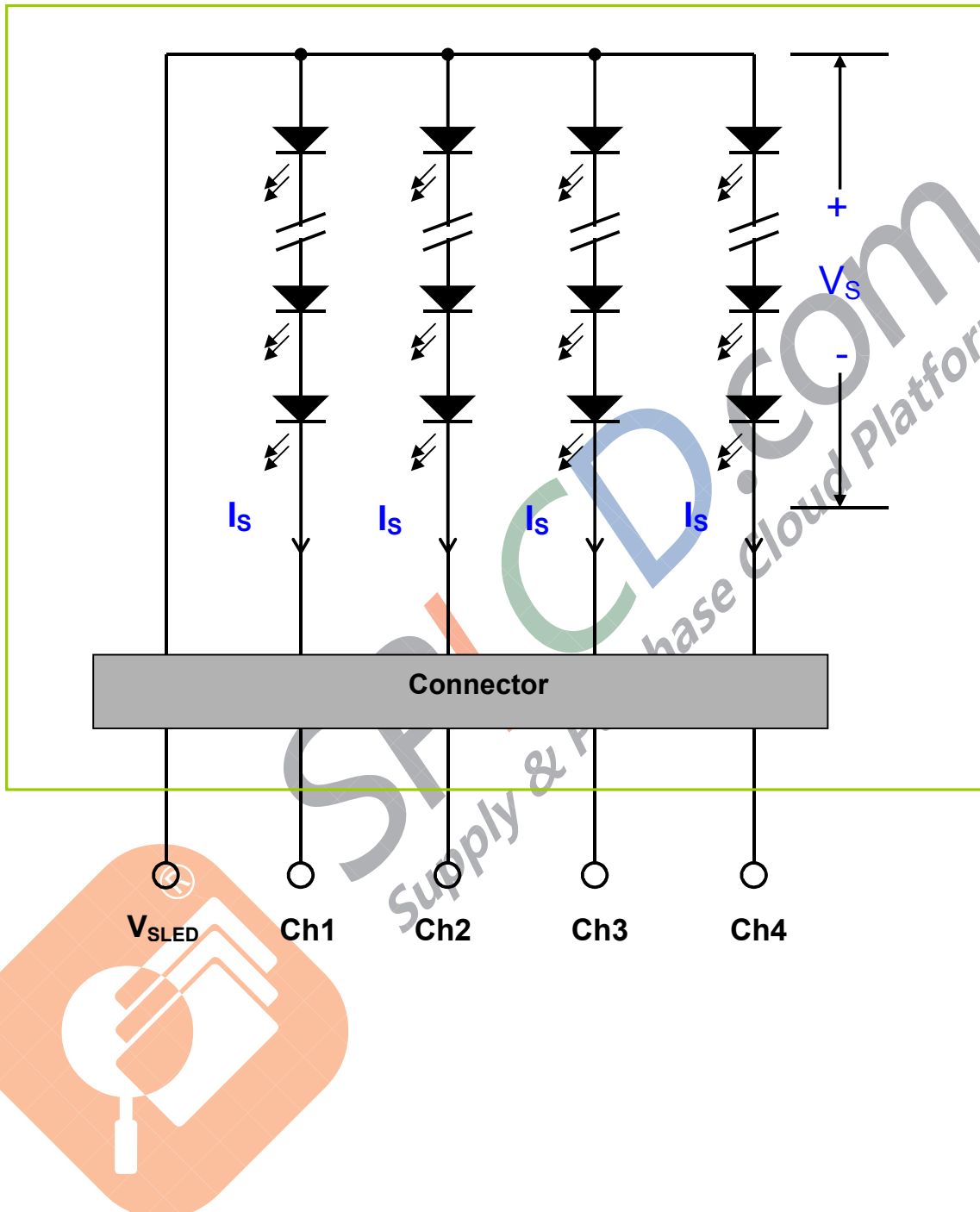

4.2 Interface Connection

4.2.1 Connector Type

Backlight Connector	Manufacturer	ENTERY
	Part Number	3707K-S06N-21R

Mating Connector	Manufacturer	ENTERY
	Part Number	H112K-P06N-13B (Locked Type)

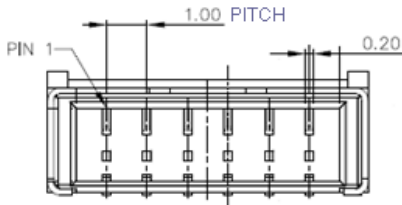
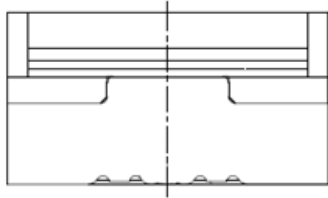
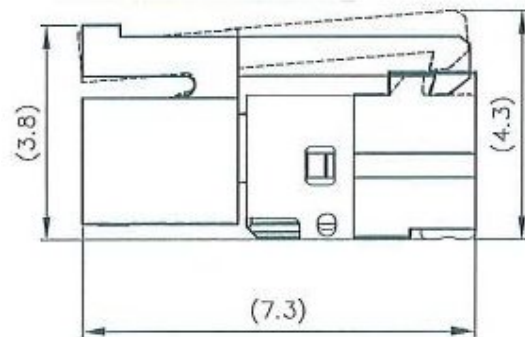
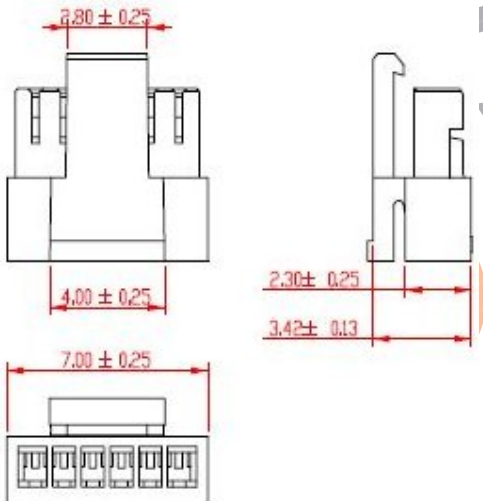
Backlight Connector dimension:
 $H \times V \times D = 13.9 \times 3.00 \times 4.25, \text{Pitch} = 1.0(\text{unit} = \text{mm})$

Mating Connector dimension:

4.2.2 Connector Pin Assignment

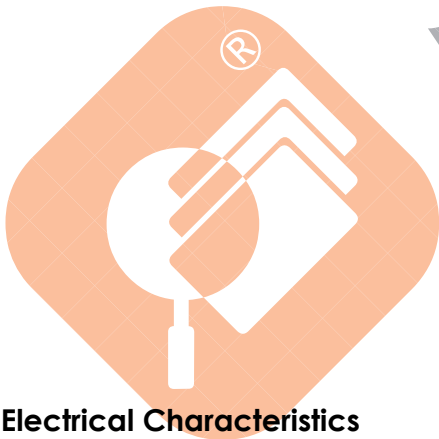
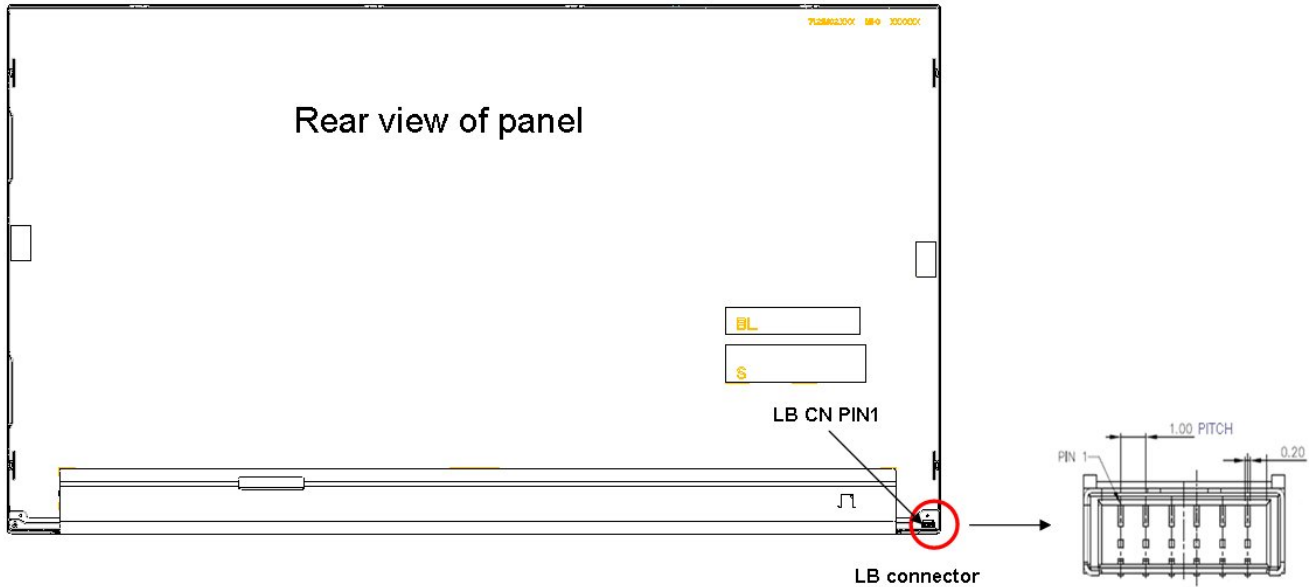
Pin#	Symbol	Description	Remark
1	Ch1	LED Current Feedback Terminal (Channel 1)	
2	Ch2	LED Current Feedback Terminal (Channel 2)	

3	V_{SLED}	LED Power Supply Voltage Input Terminal	
4	V_{SLED}	LED Power Supply Voltage Input Terminal	
5	Ch3	LED Current Feedback Terminal (Channel 3)	
6	Ch4	LED Current Feedback Terminal (Channel 4)	



ST Supply & P

4.3 Electrical Characteristics

4.3.1 Absolute Maximum Rating

Permanent damage may occur if exceeding the following maximum rating.

($T_a=25^{\circ}\text{C}$)

Symbol	Description	Min	Max	Unit	Remark
I_s	LED String Current	0	150	[mA]	100% duty ratio

			300	[mA]	Duty ratio $\leq 10\%$ Pulse time=10 ms
--	--	--	-----	------	--

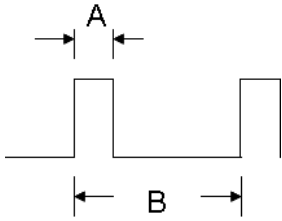

Duty ratio = $(A / B) \times 100\%$; (A: Pulse time, B: Period)

4.3.2 Recommended Operating Condition

(Ta=25°C)

Symbol	Description	Min.	Typ.	Max.	Unit	Remark
I _s	LED String Current	-	80	84	[mA]	100% duty ratio of LED chip Note 4-7
V _s	LED String Voltage	43.5	46.5	51	[Volt]	I _s =80mA @ 100% duty ratio; Note 4-1, Note 4-5
ΔV _s	Maximum V _s Voltage Deviation of light bar	-	-	3	[Volt]	I _s =80mA @ 100% duty ratio; Note 4-2
P _{BLU}	LED Light Bar Power Consumption	-	14.88	16.32	[Watt]	Note 4-3
LT _{LED}	LED Life Time	30,000	-	-	[Hour]	Note 4-4
OVP	Over Voltage Protection in system board	110% V _{smax}	-	-	[Volt]	Note 4-5

Note 4-1: V_s (Typ.) = V_F (Typ.) X LED No. (one string);

a. V_F: LED chip forward voltage, V_F (Min.)=2.8V, V_F(Typ.)=3.1V, V_F(Max.)=3.4V

b. The same equation to calculate $V_s(\text{Min.})$ & $V_s(\text{Max.})$ for respective $V_F(\text{Min.})$ & $V_F(\text{Max.})$;

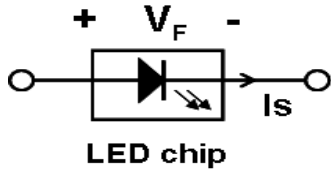

Note 4-2: $\Delta V_s(\text{Max.}) = \Delta V_F \times \text{LED No. (one string)}$;

a. ΔV_F : LED chip forward voltage deviation; (0.2 V , each Bin of LED V_F)

Note 4-3: $P_{\text{BLU}}(\text{Typ.}) = V_s(\text{Typ.}) \times I_s(\text{Typ.}) \times 4$; (4 is total String No. of LED Light bar)

$P_{\text{BLU}}(\text{Max.}) = V_s(\text{Max.}) \times I_s(\text{Typ.}) \times 4$;

Note 4-4: Definition of life time:

- a. Brightness of LED becomes to 50% of its original value
- b. Test condition: $I_s = 80\text{mA}$ and 25°C (Room Temperature)

Note 4-5: Recommendation for LED driver power design:

Due to there are electrical property deviation in LED & monitor set system component after long time operation. AUO strongly recommend the design value of LED driver board OVP (over voltage protection) should be 10% higher than max. value of LED string voltage (V_s) at least.

Note 4-6: AUO strongly recommend "Analog Dimming" method for backlight brightness control for Wavy Noise Free. Otherwise, recommend that Dimming Control Signal (PWM Signal) should be synchronized with Frame Frequency.

Note 4-7 Ensure that the LED light bar is not subjected either forward or reverse voltage while monitor set is on standby mode or not in use.

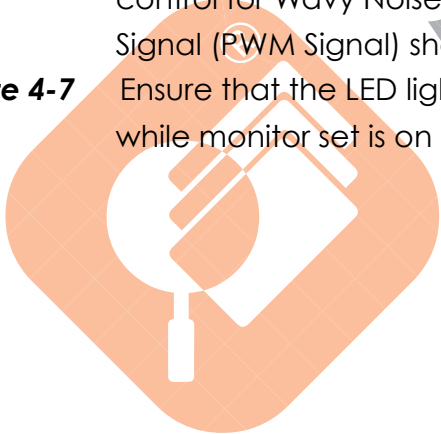

5 Reliability Test

AUO reliability test items are listed as following table. (Bare Panel only)

Items	Condition	Remark
Temperature Humidity Bias (THB)	Ta= 50°C , 80%RH, 300hours	
High Temperature Operation (HTO)	Ta= 50°C , 50%RH, 300hours	
Low Temperature Operation (LTO)	Ta= 0°C , 300hours	
High Temperature Storage (HTS)	Ta= 60°C , 300hours	
Low Temperature Storage (LTS)	Ta= -20°C , 300hours	
Vibration Test (Non-operation)	Acceleration: 1.5 Grms Wave: Random Frequency: 10 - 200 Hz Sweep: 30 Minutes each Axis (X, Y, Z)	
Shock Test (Non-operation)	Acceleration: 50 G Wave: Half-sine Active Time: 20 ms Direction: ±X, ±Y, ±Z (one time for each Axis)	
Thermal Shock Test (TST)	-20°C/30min, 60°C/30min, 100 cycles	Note 5-1
On/Off Test	On/10sec, Off/10sec, 30,000 cycles	
ESD (Electro Static Discharge)	Contact Discharge: ± 15KV, 150pF(330Ω) 1sec, 8 points, 25 times/ point.	Note 5-2
	Air Discharge: ± 15KV, 150pF(330Ω) 1sec 8 points, 25 times/ point.	
Altitude Test	Operation:18,000 ft Non-Operation:40,000 ft	

Note 5-1: a. A cycle of rapid temperature change consists of varying the temperature from -20°C to 60°C , and back again. Power is not applied during the test.
b. After finish temperature cycling, the unit is placed in normal room ambient for at least 4 hours before power on.

Note 5-2: EN61000-4-2, ESD class B: Certain performance degradation allowed
No data lost
Self-recoverable
No hardware failures.

6 Shipping Label

The label on the panel is shown as below:

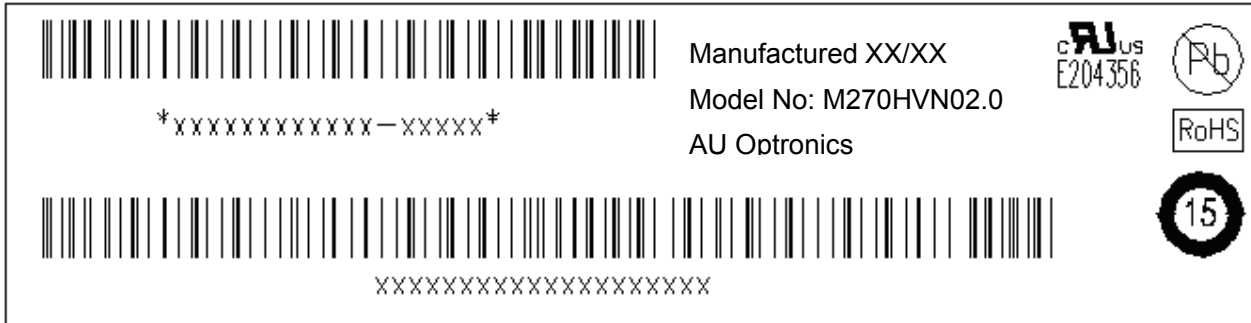

Note 6-1: For Pb Free products, AUO will add  for identification.

Note 6-2: For RoHS compatible products, AUO will add  for identification.

Note 6-3: For China RoHS compatible products, AUO will add  for identification.

Note 6-4: The Green Mark will be presented only when the green documents have been ready by AUO Internal Green Team.



7 Mechanical Characteristics

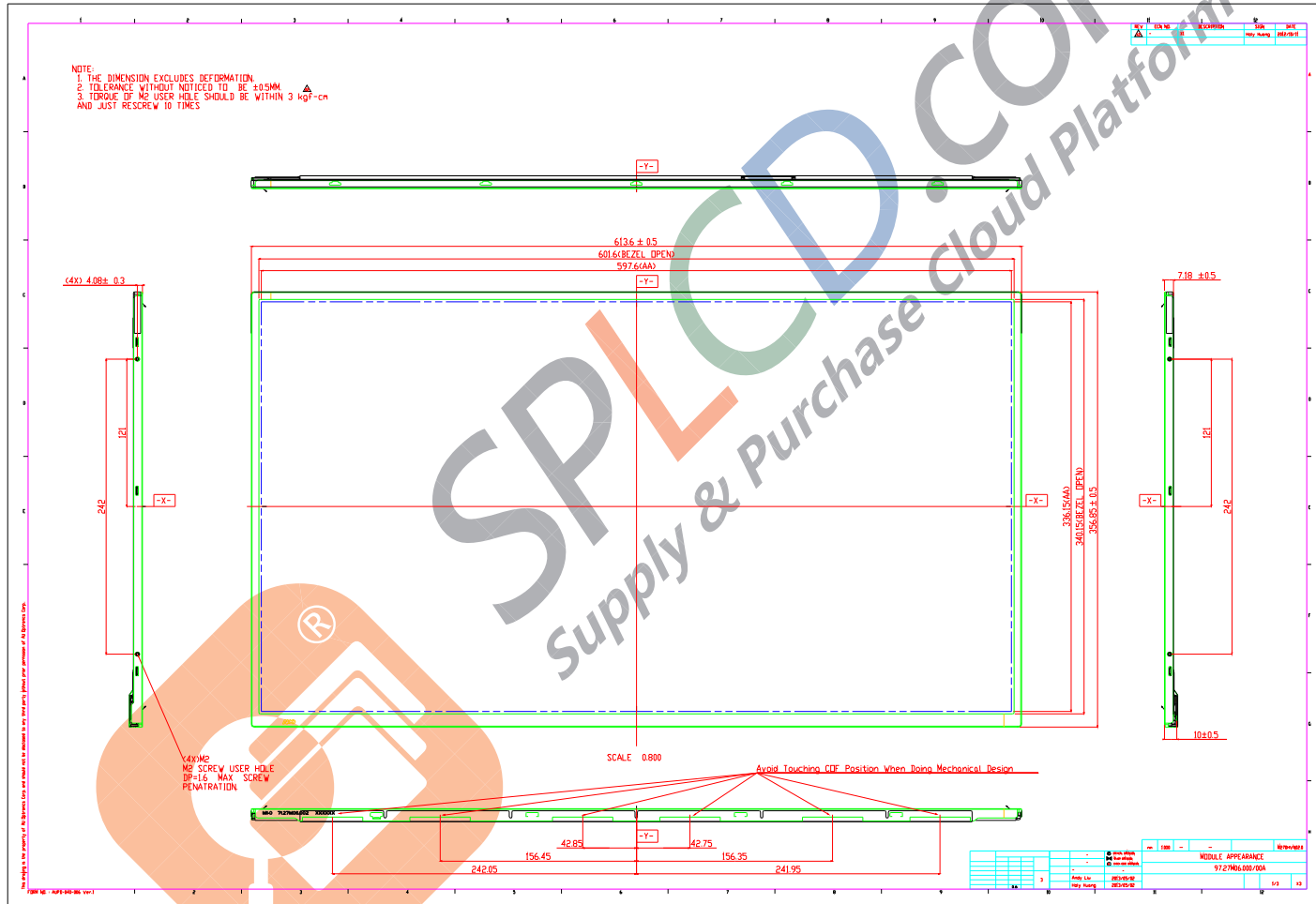

Front View

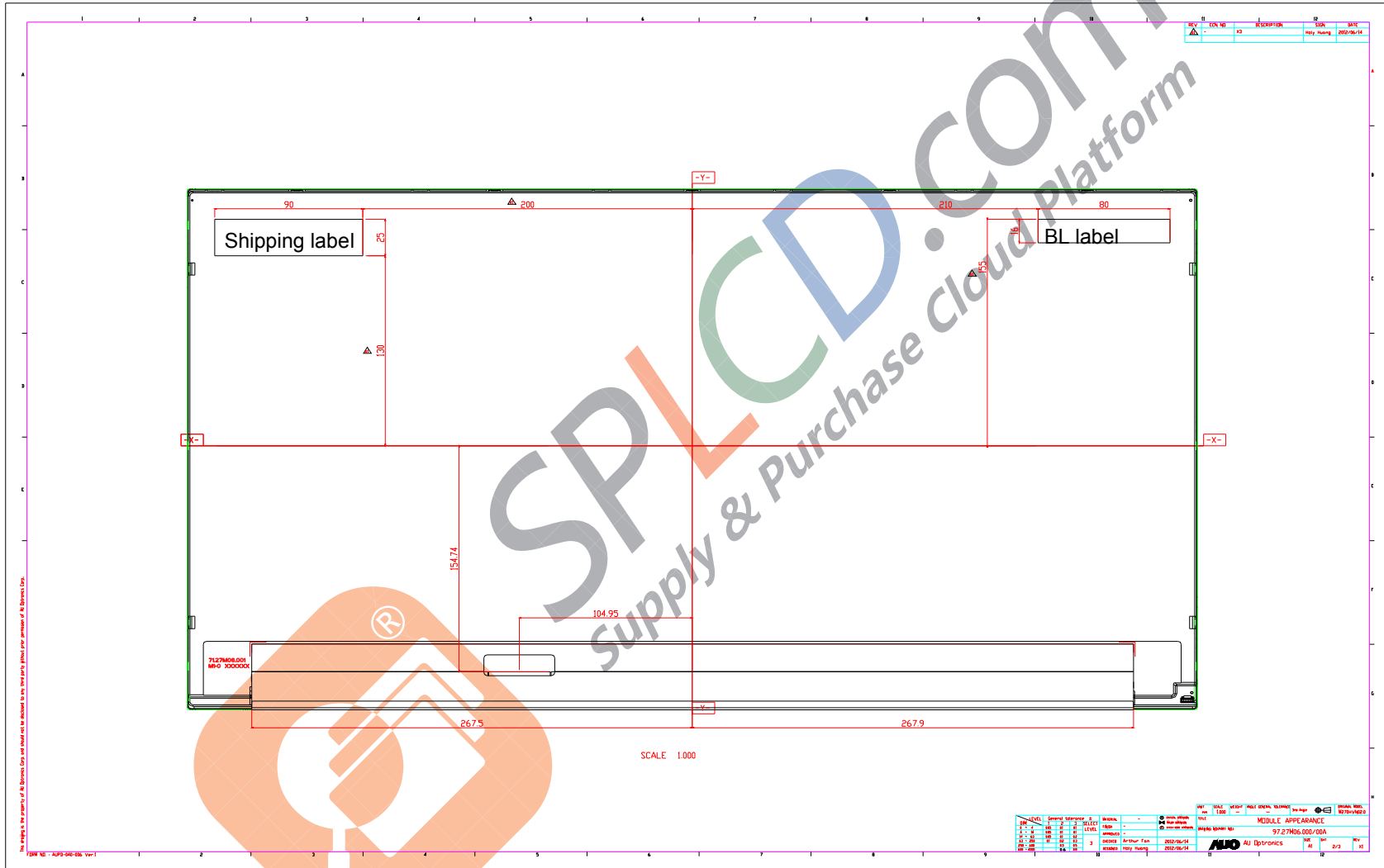

Back View

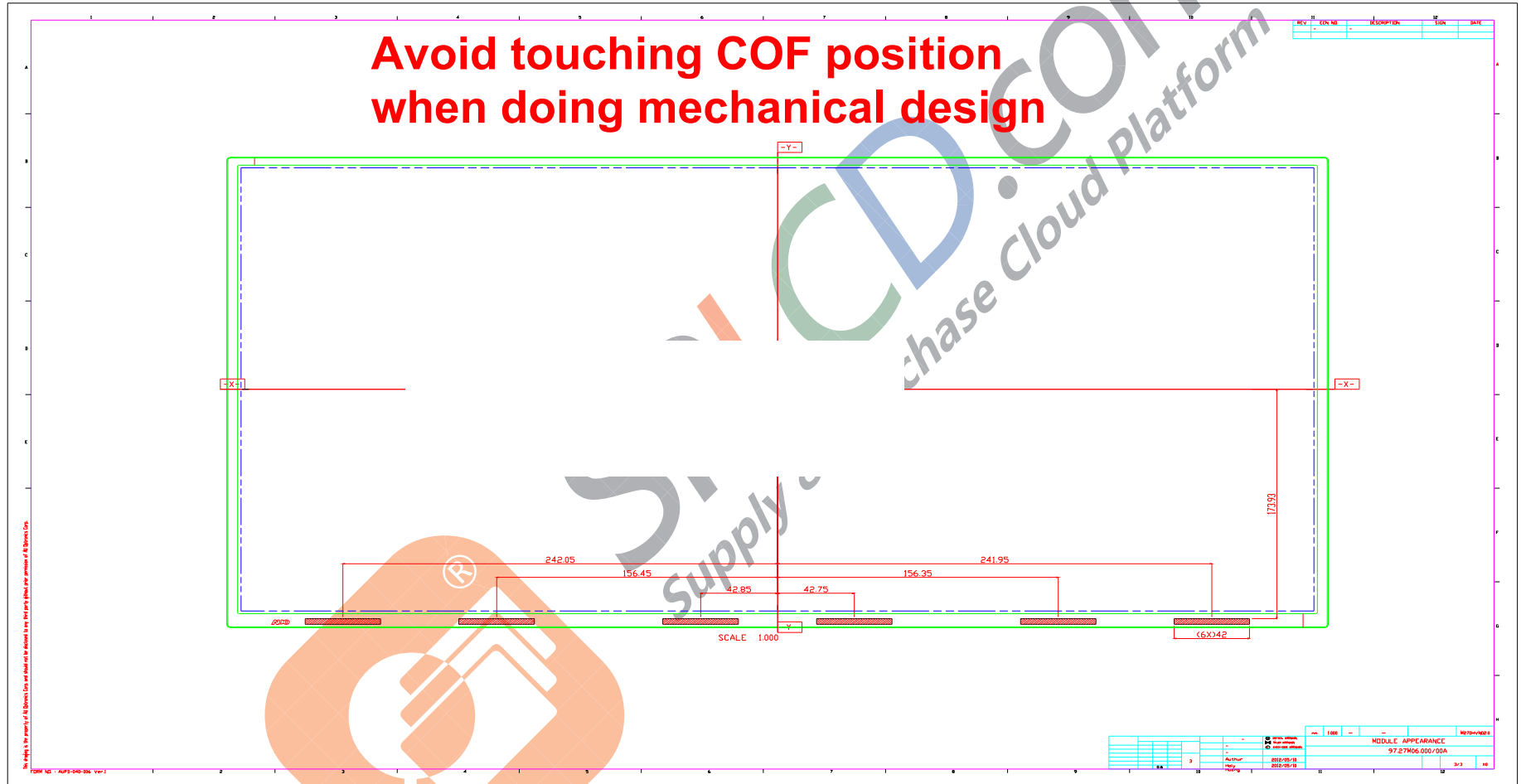

COF Position

8 Packing Specification

8.1 Packing Flow

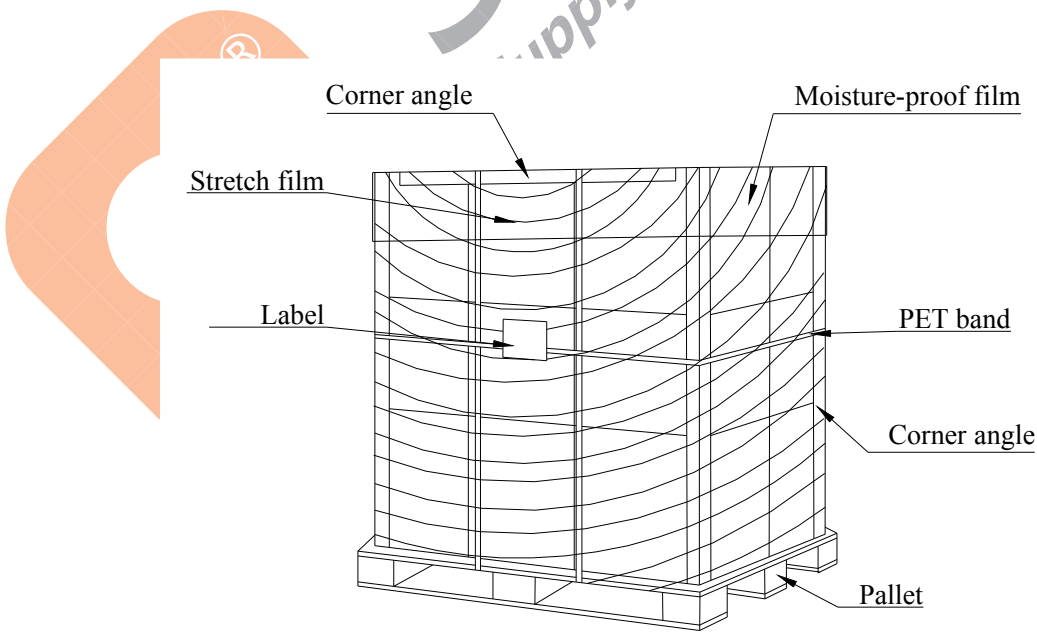
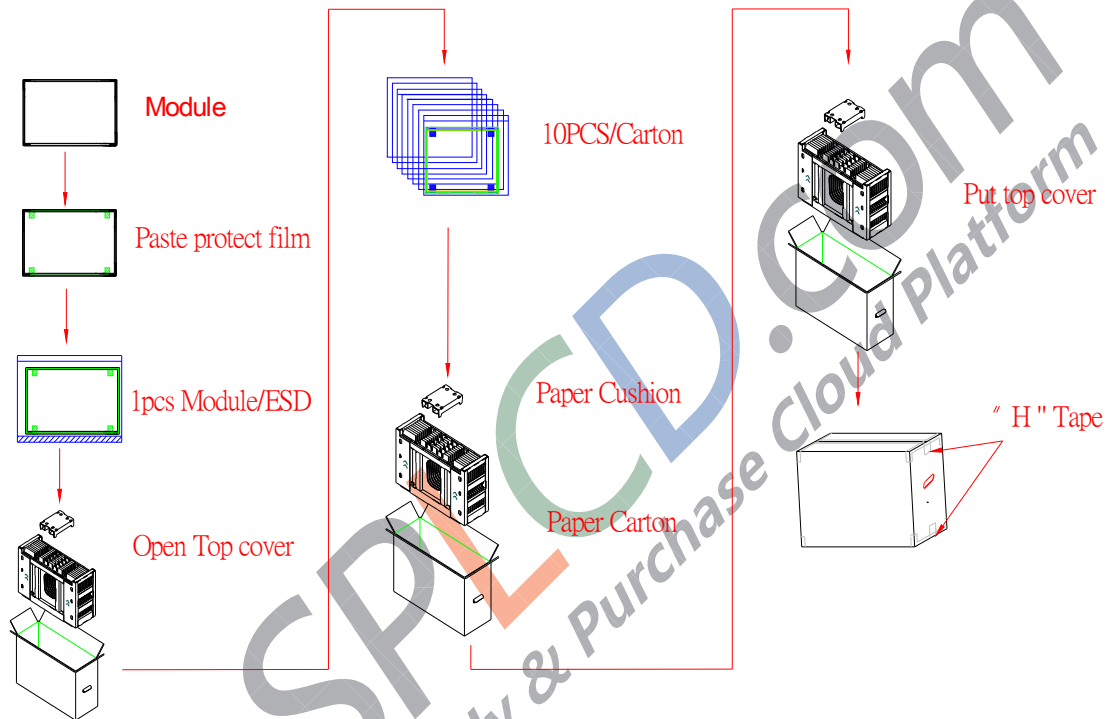

8.2 Pallet and shipment information

	Item	Specification			Remark
		Q'ty	Dimension	Weight(kg)	
1	Panel	1	613.6(H)mm x 356.85(V)mm x 10(D)mm	2.180	
2	Cushion	1	-	4.41	
3	Box	1	708(L)mm x 261(W)mm x 473(H)mm	1.38	without Panel & cushion
4	Packing Box	10 pcs/Box	708(L)mm x 261(W)mm x 473(H)mm	27.13	with panel & cushion
5	Pallet	1	1070(L)mm x 740(W)mm x 138(H)mm	12.9	
6	Pallet after Packing	8 boxes/pallet	1070(L)mm x 740(W)mm x 138(H)mm	229.94	



SPLCD.COM
 Supply & Purchase Cloud Platform