



PROPRIETARY NOTE

THIS SPECIFICATION IS THE PROPERTY OF XINSHENG AND SHALL NOT BE REPRODUCED OR COPIED WITHOUT THE WRITTEN PERMISSION OF XINSHENG AND MUST BE RETURNED TO XINSHENG UPON ITS REQUEST

SPEC. NUMBER

PRODUCT GROUP

Rev.0

ISSUE DATE

Jan. 13. 14'

PAGE

1 OF 30

TITLE : MV238FHM-N10

Preliminary Product Specification

Rev.0

Hefei Xinsheng Optoelectronics Technology Co.,LTD.



PRODUCT GROUP

REV

ISSUE DATE

TFT- LCD PRODUCT

Rev.0

Jan. 13. 14'

SPEC. NUMBER

SPEC. TITLE

MV238FHM-N10 Preliminary Product Specification_Rev.0

PAGE

2 OF 30

REVISION HISTORY

REV.	ECN No.	DESCRIPTION OF CHANGES	DATE	PREPARED
Rev.0		Initial Release	Jan. 13. 14'	JM.Huang
Rev.A		-Add MDL Weight Spec; -Add MDL Optics Spec; -Modify MDL Power Spec.	Apr.5.14'	JM.Huang
Rev.B		-Modify LVDS Connector Pin definition (AIO Project Add Bist Function) -BLU Current: 80MA----->90MA	Jun.23.14'	JM.Huang

 京东方 BOE	PRODUCT GROUP	REV	ISSUE DATE
	TFT- LCD PRODUCT	Rev.0	Jan. 13. 14'
SPEC. NUMBER	SPEC. TITLE MV238FHM-N10 Preliminary Product Specification_Rev.0		PAGE 3 OF30

Contents

No.	Item	Page
1.0	General Description	4
2.0	Absolute Maximum Ratings	6
3.0	Electrical Specifications	7
4.0	Optical Specifications	8
5.0	Interface Connection	10
6.0	Signal Timing Specifications	13
7.0	Signal Timing Waveforms of Interface Signal	15
8.0	Input Signals, Display Colors & Gray Scale of Colors	17
9.0	Power Sequence	18
10.0	Mechanical Characteristics	19
11.0	Reliability Test	20
12.0	Handling& Cautions	21
13.0	Product Serial Number	22
14.0	Packing	23
15.0	Appendix	25

 京东方 BOE	PRODUCT GROUP	REV	ISSUE DATE
	TFT- LCD PRODUCT	Rev.0	Jan. 13. 14'
SPEC. NUMBER	SPEC. TITLE MV238FHM-N10 Preliminary Product Specification_Rev.0		PAGE 4 OF30

1.0 GENERAL DESCRIPTION

1.1 Introduction

MV238FHM-N10 is a color active matrix TFT LCD module using amorphous silicon TFT's (Thin Film Transistors) as an active switching devices. This module has a 23.8 inch diagonally measured active area with FHD resolutions (1920 horizontal by 1080 vertical pixel array). Each pixel is divided into RED, GREEN, BLUE dots which are arranged in vertical stripe and this module can display 16.7M colors. The TFT-LCD panel used for this module is adapted for a low reflection and higher color type.

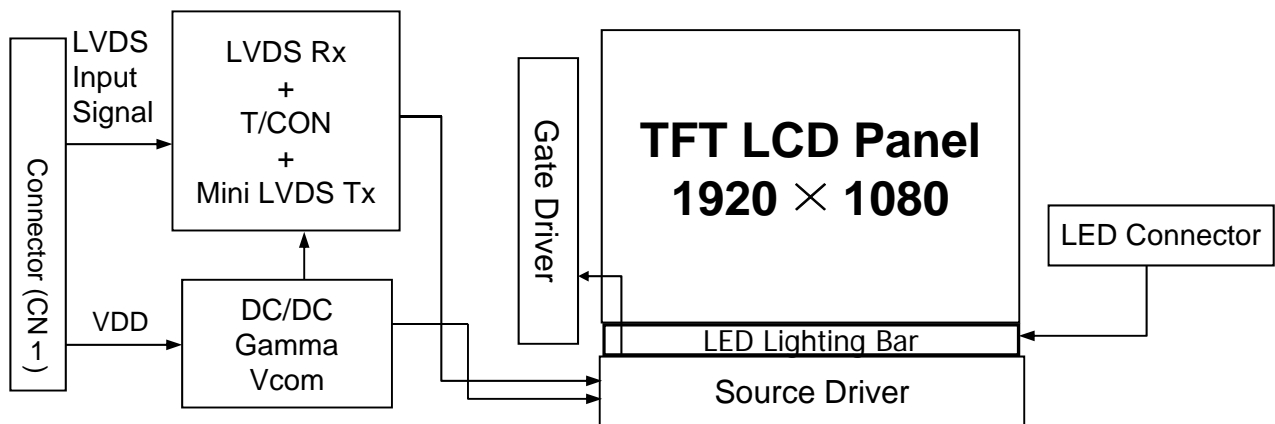

1.2 Features

- Reverse Type
- LVDS Interface with 2 pixel / clock
- High-speed response
- 6-bit (Hi-FRC) color depth, display 16. 7M colors
- Incorporated edge type back-light (LED)
- Compatible with sRGB 98% & NTSC72%
- High luminance and contrast ratio, low reflection and wide viewing angle
- DE (Data Enable) only
- RoHS/Halogen Free
- TCO 6.0, ES 6.0 compliant
- Gamma Correction

 京东方 BOE	PRODUCT GROUP	REV	ISSUE DATE
	TFT- LCD PRODUCT	Rev.0	Jan. 13. 14'
SPEC. NUMBER	SPEC. TITLE MV238FHM-N10 Preliminary Product Specification_Rev.0		PAGE 5 OF30

1.3 Application

- Desktop Type of PC & Workstation Use
- Slim-Size Display for Stand-alone Monitor
- Display Terminals for Control System
- Monitors for Process Controller

1.4 General Specification

The followings are general specifications at the model MV238FHM-N10.

<Table 1. General Specifications>

Parameter	Specification	Unit	Remarks
Active area	527.04 (H) × 296.46(V)	mm	
Number of pixels	1920(H) × 1080(V)	pixels	
Pixel pitch	0.2745(H) × 0.2745(V)	mm	
Pixel arrangement	RGB Vertical stripe		
Display colors	16.7M	colors	
Display mode	Normally Black		
Dimensional outline	543.0 (H) × 317.4(V) × 11.1(D) typ.	mm	
Weight	2390 (Typ.)	g	
Surface Treatment	Haze 25%, 3H		
Back-light	Lower edge side, 1-LED Lighting Bar type		Note 1
Power Consumption	P_D : 5.2W (max)		
	P_{BL} : 14.7W (max)		Note 2
	P_{total} : 19.9W (max)		

Notes : 1. LED Lighting Bar (3*input pins)
2. $P_{LED} = \text{Input pins} * V_{PIN} \times I_{PIN}$



PRODUCT GROUP

REV

ISSUE DATE

TFT- LCD PRODUCT

Rev.0

Jan. 13. 14'

SPEC. NUMBER

SPEC. TITLE

MV238FHM-N10 Preliminary Product Specification_Rev.0

PAGE

6 OF30

2.0 ABSOLUTE MAXIMUM RATINGS

The followings are maximum values which, if exceed, may cause faulty operation or damage to the unit. The operational and non-operational maximum voltage and current values are listed in Table 2.

< Table 2. Absolute Maximum Ratings >

[VSS=GND=0V]

Parameter	Symbol	Min.	Max.	Unit	Remarks
Power Supply Voltage	V_{DD}	-0.3	6.0	V	Ta = 25 °C
Logic Supply Voltage	V_{IN}	VSS-0.3	$V_{DD}+0.3$	V	
LED Light Bar Current Per Input Pin	IPIN	-	-	mA	Typ: 90mA(恒电流)
LED Light Bar Voltage Per Input Pin	VPIN	-	54.4	V	
Operating Temperature	T_{OP}	0	+50	°C	Note 1)
Storage Temperature	T_{ST}	-20	+60	°C	Note 1)

Note : 1) Temperature and relative humidity range are shown in the figure below.

Wet bulb temperature should be 39 °C max. and no condensation of water.

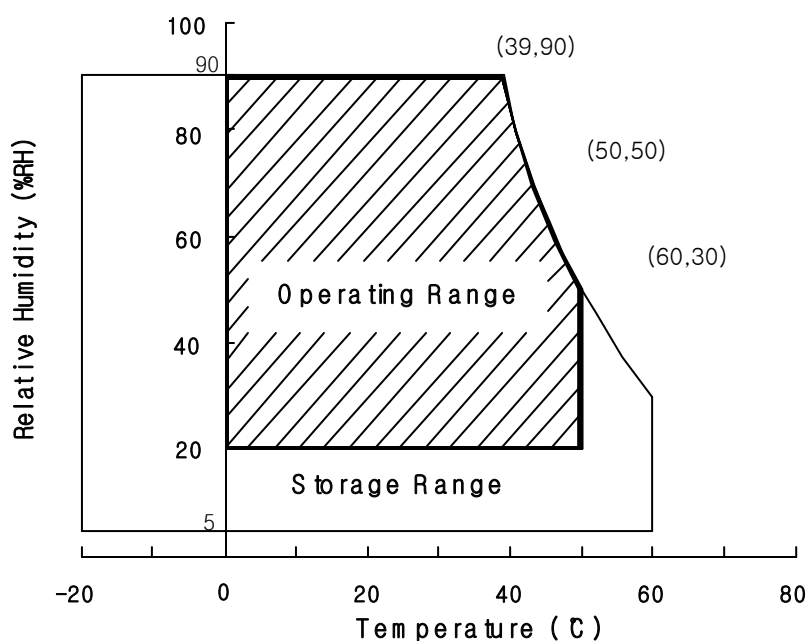

 京东方 BOE	PRODUCT GROUP	REV	ISSUE DATE
	TFT- LCD PRODUCT	Rev.0	Jan. 13. 14'
SPEC. NUMBER	SPEC. TITLE MV238FHM-N10 Preliminary Product Specification_Rev.0		PAGE 7 OF30

3.0 ELECTRICAL SPECIFICATIONS

3.1 Electrical Specifications

< Table 3. Electrical specifications >

[Ta =25±2 °C]

Parameter		Min.	Typ.	Max.	Unit	Remarks
Power Supply Voltage	V _{DD}	4.5	5.0	5.5	V	Note1
Power Supply Current	I _{DD}	-	620	1200	mA	
In-Rush Current	I _{RUSH}	-	2.0	3.0	A	Note 2
Permissible Input Ripple Voltage	V _{RF}	-	-	100	mV	V _{DD} = 5.0V
High Level Differential Input Threshold Voltage	V _{IH}	-	-	+100	mV	
Low Level Differential Input Threshold Voltage	V _{IL}	-100	-	-	mV	
Differential input voltage	V _{ID}	200	-	600	mV	
Differential input common mode voltage	V _{cm}	1.0	1.2	1.5		V _{IH} =100mV, V _{IL} =-100mV
Power Consumption	P _D	-	3.1	5.2	W	
	P _{BL}	12.6	13.8	14.7	W	Note 3
	P _{total}	-	15.4	18.3	W	

Notes: 1. The supply voltage is measured and specified at the interface connector of LCM.
The current draw and power consumption specified is for VDD=5.0V, Frame rate=75Hz
Clock frequency = 92.9 MHz. Test Pattern of power supply current

- a) Typ : Color Test
b) Max : Skip Subpixel255

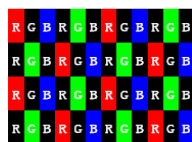

2. Duration of rush current is about 2 ms and rising time of VDD is 520 μs ± 20 %
3. Calculated value for reference (Input pins*VPIN × IPIN) excluding inverter loss.

 京东方 BOE	PRODUCT GROUP	REV	ISSUE DATE
	TFT- LCD PRODUCT	Rev.0	Jan. 13. 14'
SPEC. NUMBER	SPEC. TITLE MV238FHM-N10 Preliminary Product Specification_Rev.0		PAGE 8 OF30

3.2 Backlight Unit

< Table 4. LED Backlight Unit >

Parameter		Min.	Typ.	Max.	Unit	Remarks
LED Light Bar Input Voltage Per Input Pin	VPIN	49.6	51.2	54.4	V	Duty 100%
LED Light Bar Input Current Per Input Pin	IPIN	85	90	-	mA	Note1,2,
LED Power Consumption	P _{BL}	12.6	13.8	14.7	W	Note 3
LED Life-Time	-	30,000	-		Hrs	Note 4

Note1: There are one light bar ,and the specified current is input LED chip 100% duty current

Note2: The sense current of each input pin is 90mA

Note3: $P_{BL}=3 \text{ Input pins} \times V_{PIN} \times I_{PIN}$

Note4: The lifetime is determined as the time at which luminance of LED become 50% of the initial brightness or not normal lighting at $I_{PIN}=120\text{mA}$ on condition of continuous operating at $25 \pm 2^\circ \text{C}$

	PRODUCT GROUP	REV	ISSUE DATE
	TFT- LCD PRODUCT	Rev.0	Jan. 13. 14'
SPEC. NUMBER	SPEC. TITLE MV238FHM-N10 Preliminary Product Specification_Rev.0	PAGE 9 OF30	

4.0 OPTICAL SPECIFICATION

4.1 Overview

The test of Optical specifications shall be measured in a dark room (ambient luminance ≤ 1 lux and temperature = $25 \pm 2^\circ\text{C}$) with the equipment of Luminance meter system (Goniometer system and TOPCONE BM-5) and test unit shall be located at an approximate distance 50cm from the LCD surface at a viewing angle of θ and Φ equal to 0° . We refer to $\theta_{\theta=0}$ ($=\theta_3$) as the 3 o'clock direction (the "right"), $\theta_{\theta=90}$ ($=\theta_{12}$) as the 12 o'clock direction ("upward"), $\theta_{\theta=180}$ ($=\theta_9$) as the 9 o'clock direction ("left") and $\theta_{\theta=270}$ ($=\theta_6$) as the 6 o'clock direction ("bottom"). While scanning θ and/or Φ , the center of the measuring spot on the Display surface shall stay fixed. The measurement shall be executed after 30 minutes warm-up period. VDD shall be 5.0V +/-10% at 25°C . Optimum viewing angle direction is 6 'clock.

4.2 Optical Specifications

[VDD = 5.0V, Frame rate = 60Hz, Clock = 74.25MHz, $I_{BL} = 480\text{mA}$, $T_a = 25 \pm 2^\circ\text{C}$]

Parameter		Symbol	Condition	Min.	Typ.	Max.	Unit	Remark
Viewing Angle range	Horizontal	Θ_3	CR > 10	85	89	-	Deg.	Note 1
		Θ_9		85	89	-	Deg.	
	Vertical	Θ_{12}		85	89	-	Deg.	
		Θ_6		85	89	-	Deg.	
Luminance Contrast ratio		CR		700	1000			Note 2
Luminance of White		Y_w		200	250		cd/m ²	Note 3
White luminance uniformity		ΔY		75	80		%	Note 4
Reproduction of color	White	W_x	$\Theta = 0^\circ$ (Center) Normal Viewing Angle	0.283	0.313	0.343	-	Note 5
		W_y		0.299	0.329	0.359	-	
	Red	R_x		0.609	0.639	0.669	-	
		R_y		0.308	0.338	0.368	-	
	Green	G_x		0.267	0.297	0.327	-	
		G_y		0.586	0.616	0.646	-	
	Blue	B_x		0.121	0.151	0.181	-	
		B_y		0.023	0.053	0.083	-	
Response Time	GTG	T_g			14	20	ms	Note 6
Cross Talk		CT		-	-	2.0	%	Note 7

 京东方 BOE	PRODUCT GROUP	REV	ISSUE DATE
	TFT- LCD PRODUCT	Rev.0	Jan. 13. 14'
SPEC. NUMBER	SPEC. TITLE MV238FHM-N10 Preliminary Product Specification_Rev.0		PAGE 10 OF30

Note :

- Viewing angle is the angle at which the contrast ratio is greater than 10. The viewing are determined for the horizontal or 3, 9 o'clock direction and the vertical or 6, 12 o'clock direction with respect to the optical axis which is normal to the LCD surface.
- Contrast measurements shall be made at viewing angle of $\theta = 0^\circ$ and at the center of the LCD surface. Luminance shall be measured with all pixels in the view field set first to white, then to the dark (black) state. (See FIGURE 1 shown in Appendix) Luminance Contrast Ratio (CR) is defined mathematically.

$$CR = \frac{\text{Luminance when displaying a white raster}}{\text{Luminance when displaying a black raster}}$$

- Center Luminance of white is defined as the LCD surface. Luminance shall be measured with all pixels in the view field set first to white. This measurement shall be taken at the locations shown in FIGURE 2 for a total of the measurements per display.
- The White luminance uniformity on LCD surface is then expressed as :
 $\Delta Y = (\text{Minimum Luminance of 9points} / \text{Maximum Luminance of 9points}) * 100$
 (See FIGURE 2 shown in Appendix).
- The color chromaticity coordinates specified in Table 4. shall be calculated from the spectral data measured with all pixels first in red, green, blue and white. Measurements shall be made at the center of the panel.
- Response time Tg is the average time required for display transition by switching the input signal as below table and is based on Frame rate fV =60Hz to optimize.
 Each time in below table is defined as Figure 3 and shall be measured by switching the input signal for "any level of gray(bright)" and "any level of gray(dark)".
 (See FIGURE 3 shown in Appendix).
- Cross-Talk of one area of the LCD surface by another shall be measured by comparing the luminance (Y_A) of a 25mm diameter area, with all display pixels set to a gray level, to the luminance (Y_B) of that same area when any adjacent area is driven dark. (See FIGURE 4 shown in Appendix).

 京东方 BOE	PRODUCT GROUP	REV	ISSUE DATE
	TFT- LCD PRODUCT	Rev.0	Jan. 13. 14'
SPEC. NUMBER	SPEC. TITLE MV238FHM-N10 Preliminary Product Specification_Rev.0		PAGE 11 OF30

5.0 INTERFACE CONNECTION.

5.1 Electrical Interface Connection

5.1.1 LED Light Bar

< Table 1. LED Light Bar >

Pin No	Symbol	Description
1	IRLED1	LED current sense for string1
2	NC	NC
3	VLED	LED power supply
4	VLED	LED power supply
5	IRLED2	LED current sense for string2
6	IRLED3	LED current sense for string3
7	CONNECTOR	3708K-Q06N-00R

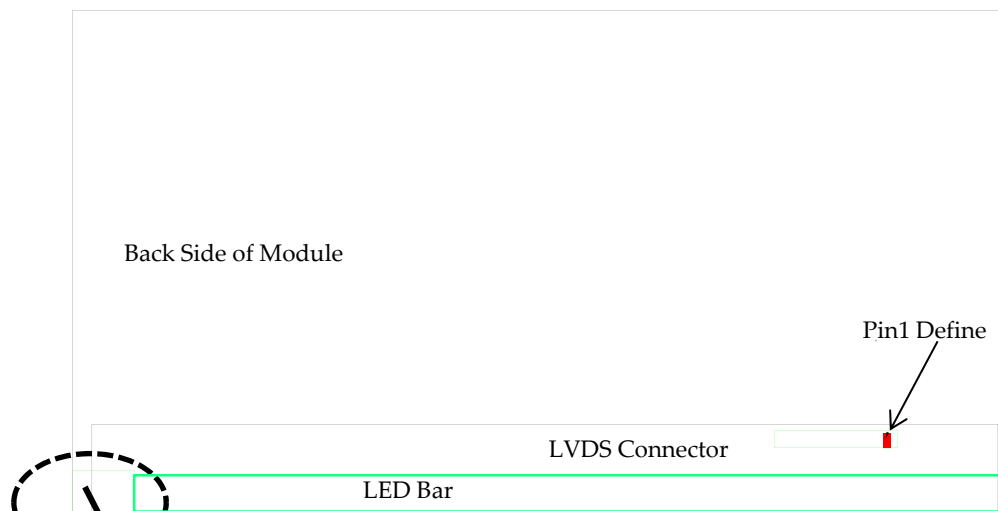

Figure1. Back Side of Module



. Detailed Pin Define of LED Bar Connector



京东方
BOE

PRODUCT GROUP

REV

ISSUE DATE

TFT- LCD PRODUCT

Rev.0

Jan. 13. 14'

SPEC. NUMBER

SPEC. TITLE

MV238FHM-N10 Preliminary Product Specification_Rev.0

PAGE

12 OF30

5.0 INTERFACE CONNECTION.

5.1 Electrical Interface Connection

- CN11 Module Side Connector : UJU IS100-L30R-C23or Equivalent
User Side Connector : JAE FI-X30H or Equivalent

Pin No	Symbol	Function	Remark
1	RXO0-	Negative Transmission data of Pixel 0 (ODD)	
2	RXO0+	Positive Transmission data of Pixel 0 (ODD)	
3	RXO1-	Negative Transmission data of Pixel 1 (ODD)	
4	RXO1+	Positive Transmission data of Pixel 1 (ODD)	
5	RXO2-	Negative Transmission data of Pixel 2 (ODD)	
6	RXO2+	Positive Transmission data of Pixel 2 (ODD)	
7	BIST	3.3V BIST ON ; Ground/NC BIST OF	
8	RXOC-	Negative Transmission Clock (ODD)	
9	RXOC+	Positive Transmission Clock (ODD)	
10	RXO3-	Negative Transmission data of Pixel 3 (ODD)	
11	RXO3+	Positive Transmission data of Pixel 3 (ODD)	
12	RXE0-	Negative Transmission data of Pixel 0 (EVEN)	
13	RXE0+	Positive Transmission data of Pixel 0 (EVEN)	
14	GND	Power Ground	
15	RXE1-	Negative Transmission data of Pixel 1 (EVEN)	
16	RXE1+	Positive Transmission data of Pixel 1 (EVEN)	
17	GND	Power Ground	
18	RXE2-	Negative Transmission data of Pixel 2 (EVEN)	
19	RXE2+	Positive Transmission data of Pixel 2 (EVEN)	
20	RXEC-	Negative Transmission Clock (EVEN)	
21	RXEC+	Positive Transmission Clock (EVEN)	
22	RXE3-	Negative Transmission data of Pixel 3 (EVEN)	
23	RXE3+	Positive Transmission data of Pixel 3 (EVEN)	
24	GND	Power Ground	Note 1
25	NC	No. Connection	
26	NC		
27	GND	Power Ground	
28	VDD	Power Supply: +5V	
29	VDD		
30	VDD		

Note 1 : This pin should be connected with GND.



京东方
BOE

PRODUCT GROUP

REV

ISSUE DATE

TFT- LCD PRODUCT

Rev.0

Jan. 13. 14'

SPEC. NUMBER

SPEC. TITLE

MV238FHM-N10 Preliminary Product Specification_Rev.0

PAGE

13 OF30

5.2 LVDS Interface (Tx; THC63LVDF83A or Equivalent)

5.2.1 LVDS Interface

	Input Signal	Transmitter		Interface		HR236WU1-100 (CN11)	Remark
		Pin No.	Pin No.	System (Tx)	TFT-LCD (Rx)	Pin No.	
L V D S	OR0	51	48 47	OUT0- OUT0+	RXO0- RXO0+	1	
	OR1	52					
	OR2	54					
	OR3	55					
	OR4	56					
	OR5	3					
	OG0	4	46 45	OUT1- OUT1+	RXO1- RXO1+	3	
	OG1	6					
	OG2	7					
	OG3	11					
	OG4	12					
	OG5	14					
	OB0	15	42 41	OUT2- OUT2+	RXO2- RXO2+	5	
	OB1	19					
	OB2	20					
	OB3	22					
	OB4	23					
	OB5	24					
	Hsync	27	8 9	CLK OUT- CLK OUT+	RXO CLK- RXO CLK+		
	Vsync	28					
	DE	30	38 37	OUT3- OUT3+	RXO3- RXO3+	10	
	MCLK	31					
	OR6	50					
	OR7	2					
OG6	8						
OG7	10						
OB6	16						
OB7	18						
RSVD	25	11					



京东方
BOE

PRODUCT GROUP

REV

ISSUE DATE

TFT- LCD PRODUCT

Rev.0

Jan. 13. 14'

SPEC. NUMBER

SPEC. TITLE

MV238FHM-N10 Preliminary Product Specification_Rev.0

PAGE

14 OF30

5.3 Data Input Format

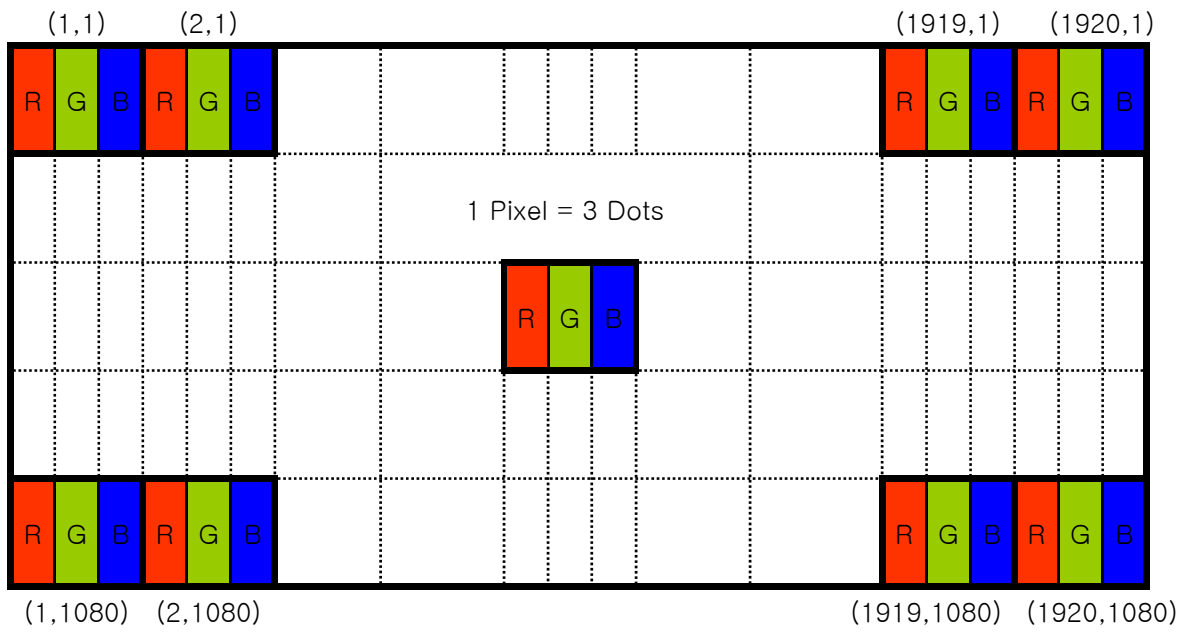

Display Position of Input Data (V-H)

 京东方 BOE	PRODUCT GROUP	REV	ISSUE DATE
	TFT- LCD PRODUCT	Rev.0	Jan. 13. 14'
SPEC. NUMBER	SPEC. TITLE MV238FHM-N10 Preliminary Product Specification_Rev.0		PAGE 15 OF30

6.0 SIGNAL TIMING SPECIFICATION

6.1 The MV238FHM-N10 is operated by the DE only.

Item		Symbols	Min	Typ	Max	Unit
Clock	Frequency	1/Tc	57	74.25	97	MHz
	High Time	Tch	-	4/7Tc	-	
	Low Time	Tcl	-	4/7Tc	-	
Frame Period		Tv	1108	1126	1252	lines
			50	60	75	Hz
			20	16.7	13.3	ms
Vertical Display Period		Tvd	-	1080	-	lines
One line Scanning Period		Th	1050	1100	1150	clocks
Horizontal Display Period		Thd	960	960	960	clocks
Horizontal Frequency		Fh	56	68	90	KHz

Note: The DCLK range at last line of V-blanking should be set in 0~987



PRODUCT GROUP

REV

ISSUE DATE

TFT- LCD PRODUCT

Rev.0

Jan. 13. 14'

SPEC. NUMBER

SPEC. TITLE

MV238FHM-N10 Preliminary Product Specification_Rev.0

PAGE

16 OF30

6.2 LVDS Rx Interface Timing Parameter

The specification of the LVDS Rx interface timing parameter is shown in Table 4.

<Table 4. LVDS Rx Interface Timing Specification>

Item	Symbol	Min	Typ	Max	Unit	Remark
CLKIN Period	tRCIP	10.20	13.47	17.08	nsec	
Input Data 0	tRIP1	-0.4	0.0	+0.4	nsec	
Input Data 1	tRIP0	tRCIP/7-0.4	tRCIP/7	tRCIP/7+0.4	nsec	
Input Data 2	tRIP6	2 × tRCIP/7-0.4	2 × tRCIP/7	2 × tRCIP/7+0.4	nsec	
Input Data 3	tRIP5	3 × tRCIP/7-0.4	3 × tRCIP/7	3 × tRCIP/7+0.4	nsec	
Input Data 4	tRIP4	4 × tRCIP/7-0.4	4 × tRCIP/7	4 × tRCIP/7+0.4	nsec	
Input Data 5	tRIP3	5 × tRCIP/7-0.4	5 × tRCIP/7	5 × tRCIP/7+0.4	nsec	
Input Data 6	tRIP2	6 × tRCIP/7-0.4	6 × tRCIP/7	6 × tRCIP/7+0.4	nsec	

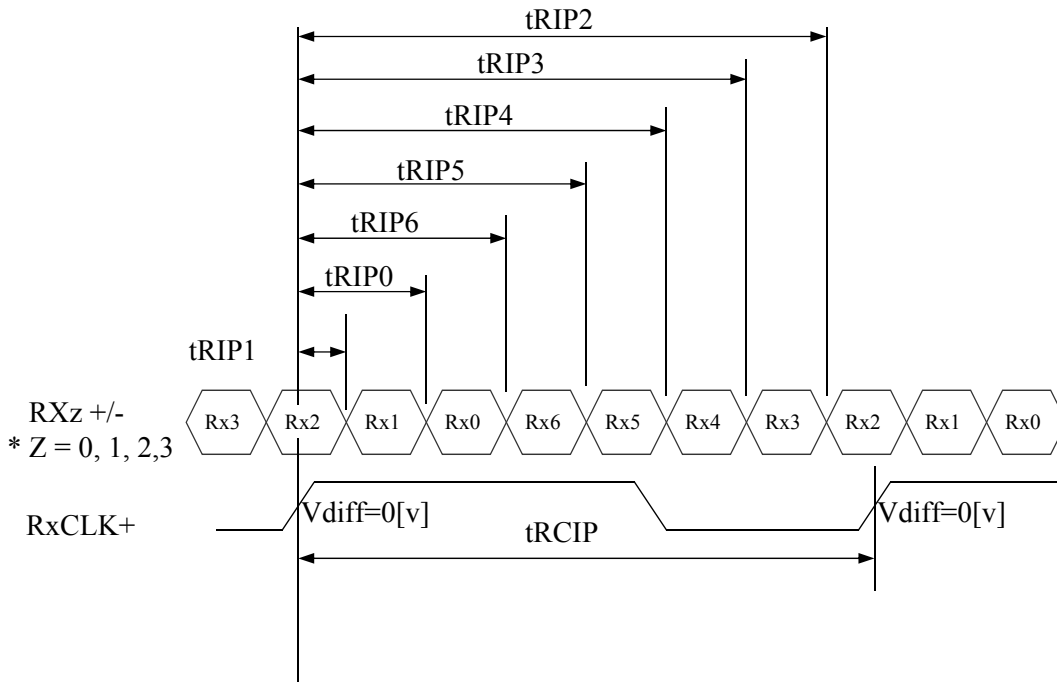

* Vdiff = (RXz+)-(RXz-),... ,(RXCLK+)-(RXCLK-)



PRODUCT GROUP

REV

ISSUE DATE

TFT- LCD PRODUCT

Rev.0

Jan. 13. 14'

SPEC. NUMBER

SPEC. TITLE

MV238FHM-N10 Preliminary Product Specification_Rev.0

PAGE

17 OF30

7.0 SIGNAL TIMING WAVEFORMS OF INTERFACE SIGNAL

7.1 Sync Timing Waveforms

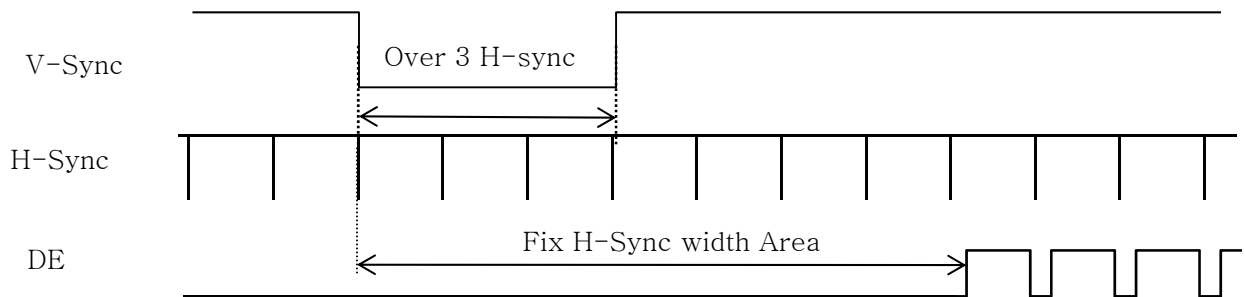

- 1) Need over 3 H-sync during V-Sync Low
- 2) Fix H-Sync width from V-Sync falling edge to first rising edge

7.2 Vertical Timing Waveforms

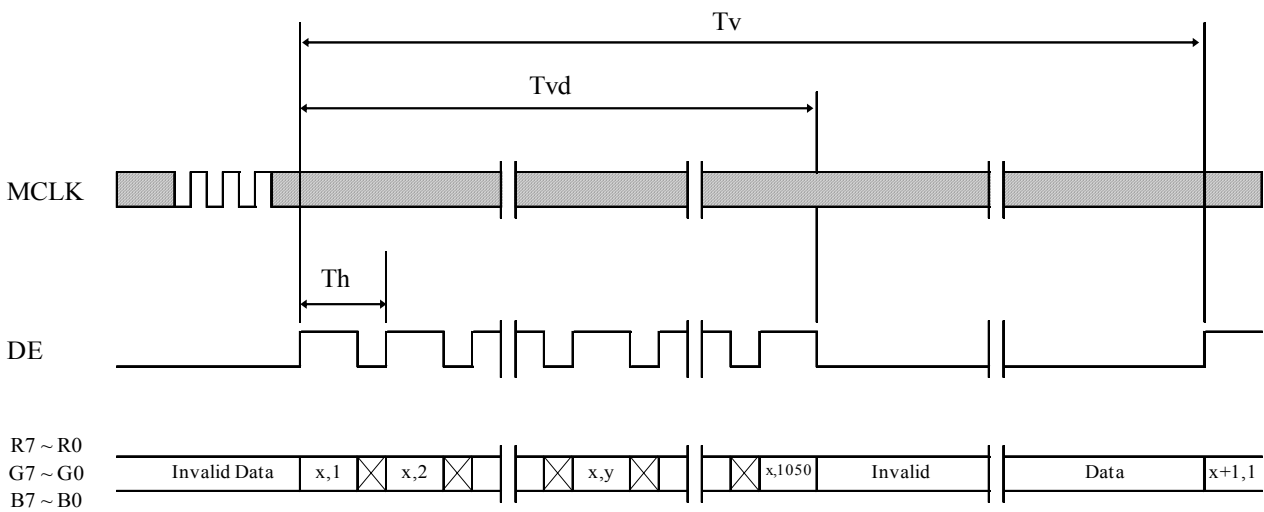



PRODUCT GROUP

REV

ISSUE DATE

TFT- LCD PRODUCT

Rev.0

Jan. 13. 14'

SPEC. NUMBER

SPEC. TITLE
MV238FHM-N10 Preliminary Product Specification_Rev.0

PAGE
18 OF30

7.3 Horizontal Timing Waveforms

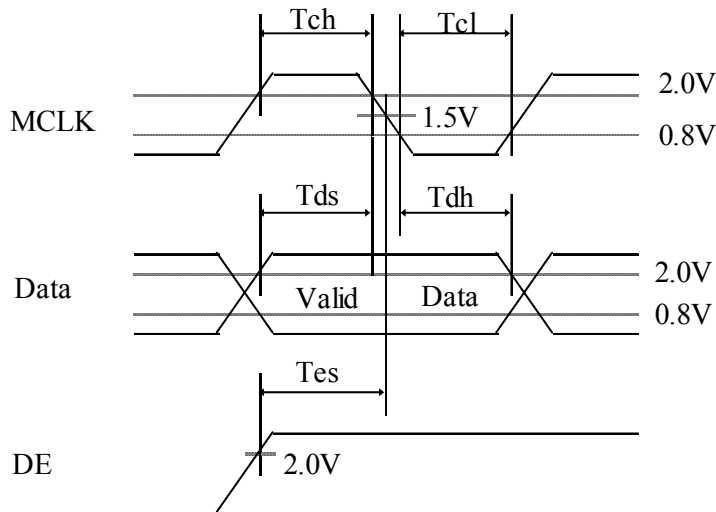
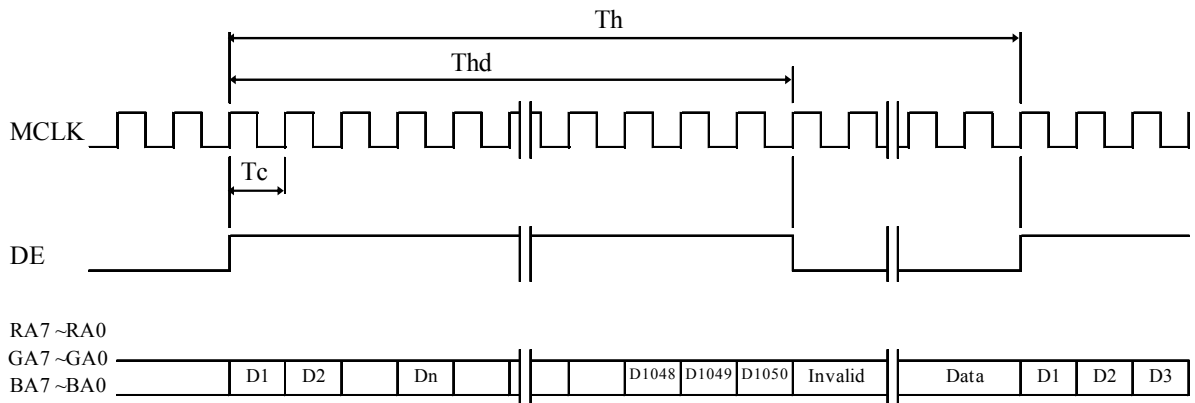



PRODUCT GROUP

REV

ISSUE DATE

TFT- LCD PRODUCT

Rev.0

Jan. 13. 14'

SPEC. NUMBER

SPEC. TITLE

MV238FHM-N10 Preliminary Product Specification_Rev.0

PAGE

19 OF30

8.0 INPUT SIGNALS, BASIC DISPLAY COLORS & GRAY SCALE OF COLORS

Color & Gray Scale		RED DATA								GREEN DATA								BLUE DATA							
		R7	R6	R5	R4	R3	R2	R1	R0	G7	G6	G5	G4	G3	G2	G1	G0	B7	B6	B5	B4	B3	B2	B1	B0
Basic Colors	Black	0	0	0	0	0	0	0	0	0	0	0	0	0	0	0	0	0	0	0	0	0	0	0	0
	Blue	0	0	0	0	0	0	0	0	0	0	0	0	0	0	0	0	1	1	1	1	1	1	1	1
	Green	0	0	0	0	0	0	0	0	1	1	1	1	1	1	1	1	0	0	0	0	0	0	0	0
	Cyan	0	0	0	0	0	0	0	0	1	1	1	1	1	1	1	1	1	1	1	1	1	1	1	1
	Red	1	1	1	1	1	1	1	1	0	0	0	0	0	0	0	0	0	0	0	0	0	0	0	0
	Magenta	1	1	1	1	1	1	1	1	0	0	0	0	0	0	0	0	1	1	1	1	1	1	1	1
	Yellow	1	1	1	1	1	1	1	1	1	1	1	1	1	1	1	1	0	0	0	0	0	0	0	0
	White	1	1	1	1	1	1	1	1	1	1	1	1	1	1	1	1	1	1	1	1	1	1	1	1
Gray Scale of RED	Black	0	0	0	0	0	0	0	0	0	0	0	0	0	0	0	0	0	0	0	0	0	0	0	0
	△	0	0	0	0	0	0	1	0	0	0	0	0	0	0	0	0	0	0	0	0	0	0	0	0
	Darker	0	0	0	0	0	0	1	0	0	0	0	0	0	0	0	0	0	0	0	0	0	0	0	0
	△	↑								↑								↑							
	▽	↓								↓								↓							
	Brighter	1	1	1	1	1	1	0	1	0	0	0	0	0	0	0	0	0	0	0	0	0	0	0	0
	▽	1	1	1	1	1	1	1	0	0	0	0	0	0	0	0	0	0	0	0	0	0	0	0	0
	Red	1	1	1	1	1	1	1	1	0	0	0	0	0	0	0	0	0	0	0	0	0	0	0	0
Gray Scale of GREEN	Black	0	0	0	0	0	0	0	0	0	0	0	0	0	0	0	0	0	0	0	0	0	0	0	0
	△	0	0	0	0	0	0	0	0	0	0	0	0	0	0	0	1	0	0	0	0	0	0	0	0
	Darker	0	0	0	0	0	0	0	0	0	0	0	0	0	0	1	0	0	0	0	0	0	0	0	0
	△	↑								↑								↑							
	▽	↓								↓								↓							
	Brighter	0	0	0	0	0	0	0	0	1	1	1	1	1	1	0	1	0	0	0	0	0	0	0	0
	▽	0	0	0	0	0	0	0	0	1	1	1	1	1	1	1	0	0	0	0	0	0	0	0	0
	Green	0	0	0	0	0	0	0	0	1	1	1	1	1	1	1	1	0	0	0	0	0	0	0	0
Gray Scale of BLUE	Black	0	0	0	0	0	0	0	0	0	0	0	0	0	0	0	0	0	0	0	0	0	0	0	0
	△	0	0	0	0	0	0	0	0	0	0	0	0	0	0	0	0	0	0	0	0	0	0	0	1
	Darker	0	0	0	0	0	0	0	0	0	0	0	0	0	0	0	0	0	0	0	0	0	0	0	1
	△	↑								↑								↑							
	▽	↓								↓								↓							
	Brighter	0	0	0	0	0	0	0	0	0	0	0	0	0	0	0	0	1	1	1	1	1	1	0	1
	▽	0	0	0	0	0	0	0	0	0	0	0	0	0	0	0	0	1	1	1	1	1	1	1	0
	Blue	0	0	0	0	0	0	0	0	0	0	0	0	0	0	0	0	1	1	1	1	1	1	1	1
Gray Scale of WHITE	Black	0	0	0	0	0	0	0	0	0	0	0	0	0	0	0	0	0	0	0	0	0	0	0	0
	△	0	0	0	0	0	0	1	0	0	0	0	0	0	0	0	1	0	0	0	0	0	0	0	1
	Darker	0	0	0	0	0	0	1	0	0	0	0	0	0	0	1	0	0	0	0	0	0	0	1	0
	△	↑								↑								↑							
	▽	↓								↓								↓							
	Brighter	1	1	1	1	1	1	0	1	1	1	1	1	1	1	0	1	1	1	1	1	1	1	0	1
	▽	1	1	1	1	1	1	1	0	1	1	1	1	1	1	1	0	1	1	1	1	1	1	1	0
	White	1	1	1	1	1	1	1	1	1	1	1	1	1	1	1	1	1	1	1	1	1	1	1	1

9.0 POWER SEQUENCE

To prevent a latch-up or DC operation of the LCD module, the power on/off sequence shall be as shown in below

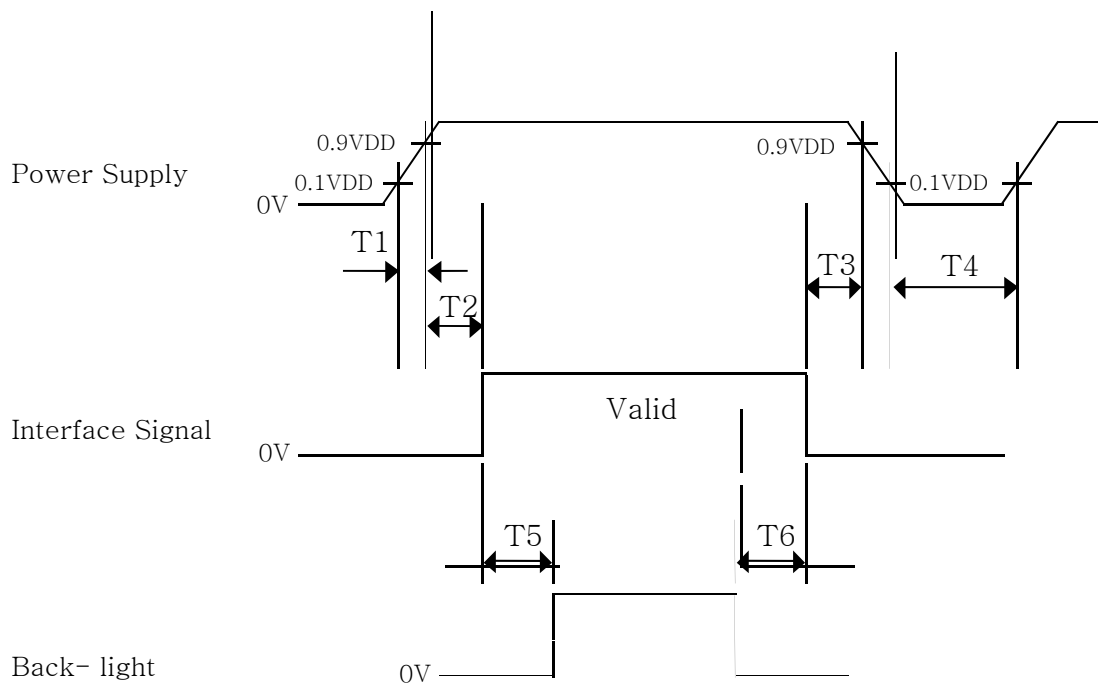

- $0.5 \text{ ms} \leq T1 \leq 10 \text{ ms}$
- $0 \leq T2 \leq 50 \text{ ms}$
- $0 \leq T3 \leq 50 \text{ ms}$
- $1 \text{ sec} \leq T4$
- $200 \text{ ms} \leq T5$
- $200 \text{ ms} \leq T6$

Notes:

1. When the power supply VDD is 0V, keep the level of input signals on the low or keep high impedance.
2. Do not keep the interface signal high impedance when power is on.
3. Back Light must be turn on after power for logic and interface signal are valid.

 京东方 BOE	PRODUCT GROUP	REV	ISSUE DATE
	TFT- LCD PRODUCT	Rev.0	Jan. 13. 14'
SPEC. NUMBER	SPEC. TITLE MV238FHM-N10 Preliminary Product Specification_Rev.0		PAGE 21 OF30

10.0 MECHANICAL CHARACTERISTICS

10.1 Dimensional Requirements

FIGURE 6 (located in Appendix) shows mechanical outlines for the model MV238FHM-N10. Other parameters are shown in Table 5.

<Table 5. Dimensional Parameters>

Parameter	Specification	Unit
Dimensional outline	543.0(H) × 317.4(V) × 11.1(D) typ.	mm
Weight	2390(typ.)	gram
Active area	527.04 (H) × 296.46 (V)	mm
Pixel pitch	0.2745 (H) × 0.2745 (V)	mm
Number of pixels	1920 (H) × 1080 (V) (1 pixel = R + G + B dots)	pixels
Back-light	Lower edge side, 1-LED Lighting Bar type	

10.2 Mounting

Left & Right each side have two user holes(See MDL Mechanical Drawing).

10.3 Anti-Glare and Polarizer Hardness.

The surface of the LCD has an anti-glare coating to minimize reflection and a coating to reduce scratching.

10.4 Light Leakage

There shall not be visible light from the back-lighting system around the edges of the screen as seen from a distance 50cm from the screen with an overhead light level of 350lux.



京东方
BOE

PRODUCT GROUP

REV

ISSUE DATE

TFT- LCD PRODUCT

Rev.0

Jan. 13. 14'

SPEC. NUMBER

SPEC. TITLE

MV238FHM-N10 Preliminary Product Specification_Rev.0

PAGE

22 OF30

11.0 RELIABILITY TEST

The Reliability test items and its conditions are shown in below.

<Table 6. Reliability Test Parameters >

No	Test Items	Conditions	
1	High temperature storage test	Ta = 60 °C, 240 hrs	
2	Low temperature storage test	Ta = -20 °C, 240 hrs	
3	High temperature & high humidity operation test	Ta = 50 °C, 80%RH, 240hrs	
4	High temperature operation test	Ta = 50 °C, 240hrs	
5	Low temperature operation test	Ta = 0°C, 240hrs	
6	Thermal shock	Ta = -20 °C ↔ 60 °C (0.5 hr), 100 cycle	
7	Vibration test (non-operating)	Frequency	Random, 10 ~ 300 Hz, 30 min/Axis
		Gravity / AMP	1.5 Grms
		Period	X, Y, Z 30 min
8	Shock test (non-operating)	Gravity	50G
		Pulse width	11msec, sine wave
		Direction	± X, ± Y, ± Z Once for each
9	Electro-static discharge test (non-operating)	Air : 150 pF, 330Ω, 15 KV	Contact : 150 pF, 330Ω, 8 KV

 京东方 BOE	PRODUCT GROUP	REV	ISSUE DATE
	TFT- LCD PRODUCT	Rev.0	Jan. 13. 14'
SPEC. NUMBER	SPEC. TITLE MV238FHM-N10 Preliminary Product Specification_Rev.0		PAGE 23 OF30

12.0 HANDLING & CAUTIONS

- (1) Cautions when taking out the module
 - Pick the pouch only, when taking out module from a shipping package.
- (2) Cautions for handling the module
 - As the electrostatic discharges may break the LCD module, handle the LCD module with care. Peel a protection sheet off from the LCD panel surface as slowly as possible.
 - As the LCD panel and back - light element are made from fragile glass material, impulse and pressure to the LCD module should be avoided.
 - As the surface of the polarizer is very soft and easily scratched, use a soft dry cloth without chemicals for cleaning.
 - Do not pull the interface connector in or out while the LCD module is operating.
 - Put the module display side down on a flat horizontal plane.
 - Handle connectors and cables with care.
- (3) Cautions for the operation
 - When the module is operating, do not lose CLK, ENAB signals. If any one of these signals is lost, the LCD panel would be damaged.
 - Obey the supply voltage sequence. If wrong sequence is applied, the module would be damaged.
- (4) Cautions for the atmosphere
 - Dew drop atmosphere should be avoided.
 - Do not store and/or operate the LCD module in a high temperature and/or humidity atmosphere. Storage in an electro-conductive polymer packing pouch and under relatively low temperature atmosphere is recommended.
- (5) Cautions for the module characteristics
 - Do not apply fixed pattern data signal to the LCD module at product aging.
 - Applying fixed pattern for a long time may cause image sticking.
- (6) Other cautions
 - Do not disassemble and/or re-assemble LCD module.
 - Do not re-adjust variable resistor or switch etc.
 - When returning the module for repair or etc., Please pack the module not to be broken. We recommend to use the original shipping packages.

	PRODUCT GROUP	REV	ISSUE DATE
	TFT- LCD PRODUCT	Rev.0	Jan. 13. 14'
SPEC. NUMBER	SPEC. TITLE MV238FHM-N10 Preliminary Product Specification_Rev.0		PAGE 24 OF30

13.0 PRODUCT SERIAL NUMBER







MV238FHM-N10



XXXXXXXXXXXXXXXXXXXX



MADE IN CHINA XXXXXXXXXXXXXXXXXXXXXXX

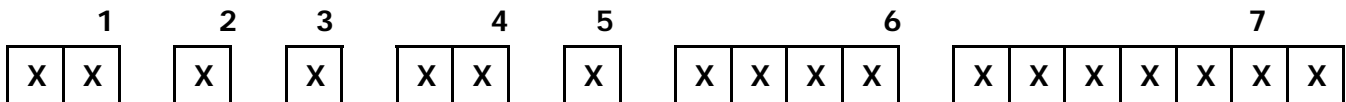

- | | |
|---|---|
| <ul style="list-style-type: none"> 1. Control Number 2. Rank / Grade 3. Line Classification 4. Year (2001 : 01, 2002 : 02, ...) | <ul style="list-style-type: none"> 5. Month (1,2,3, ... , 9, X, Y, Z) 6. Internal Use 7. Serial Number |
|---|---|

 京东方 BOE	PRODUCT GROUP	REV	ISSUE DATE
	TFT- LCD PRODUCT	Rev.0	Jan. 13. 14'
SPEC. NUMBER	SPEC. TITLE MV238FHM-N10 Preliminary Product Specification_Rev.0		PAGE 25 OF30

14.0 Packing

14.1 Packing Order

Put pad into the box

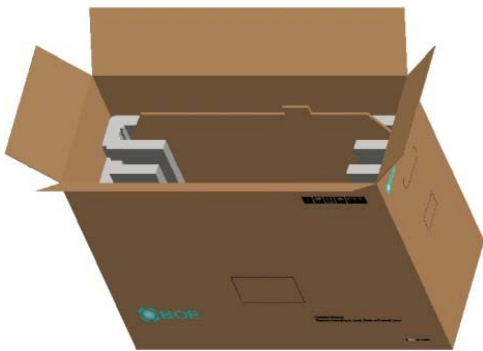

Place the modules bundled by packing bag in the box, 8pcs module per box, place a cover on the top of the box

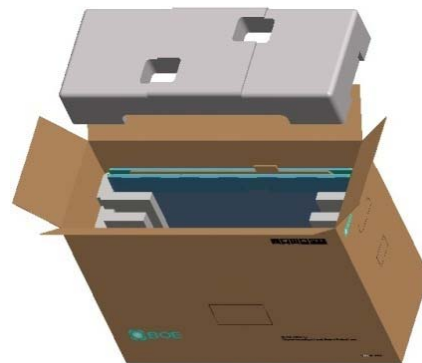

12ea box per pallet

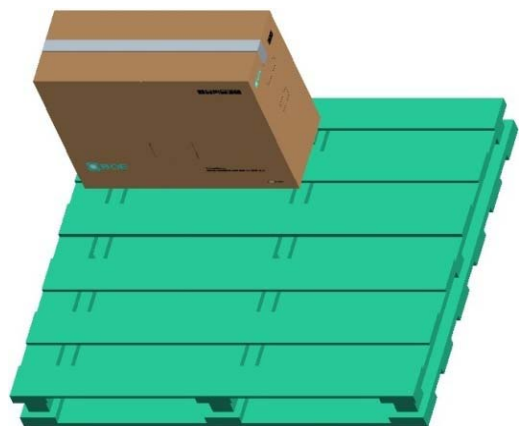

After sealing the box, put the box on the pallet

 京东方 BOE	PRODUCT GROUP	REV	ISSUE DATE
	TFT- LCD PRODUCT	Rev.0	Jan. 13. 14'
SPEC. NUMBER	SPEC. TITLE MV238FHM-N10 Preliminary Product Specification_Rev.0		PAGE 26 OF30

14.2 Packing Note

- Box Dimension : 235mm(W) × 615mm(L) × 448mm(H)
- Package Quantity in one Box : 8 pcs

14.3 Box label

- Label Size : 110mm (L) × 55 mm (W)
- Contents
Model : MV238FHM-N10
Q'ty : Module 8 Q'ty in one box
Serial No. : Box Serial No. See next page for detail description.
Date : Packing Date

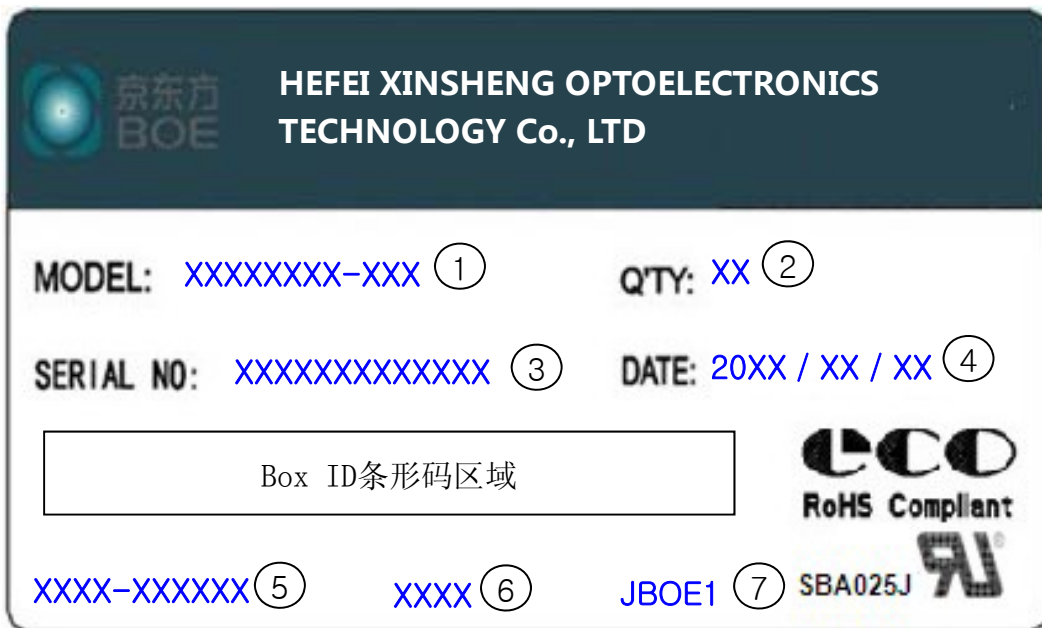

蓝色字体为后打印标识, 说明如下:

- | | |
|------------------------|-------------------|
| 1. FG-CODE | 2. Box 产品数量 |
| 3. Box ID, 编码规则(CIM提供) | 4. Box Packing 日期 |
| 5. 产品物料号(客户端)(FAE提供) | 6. FG-CODE 后四位 |
| 7. 供应商代码 | |

15.0 APPENDIX

Figure 1. Measurement Set Up

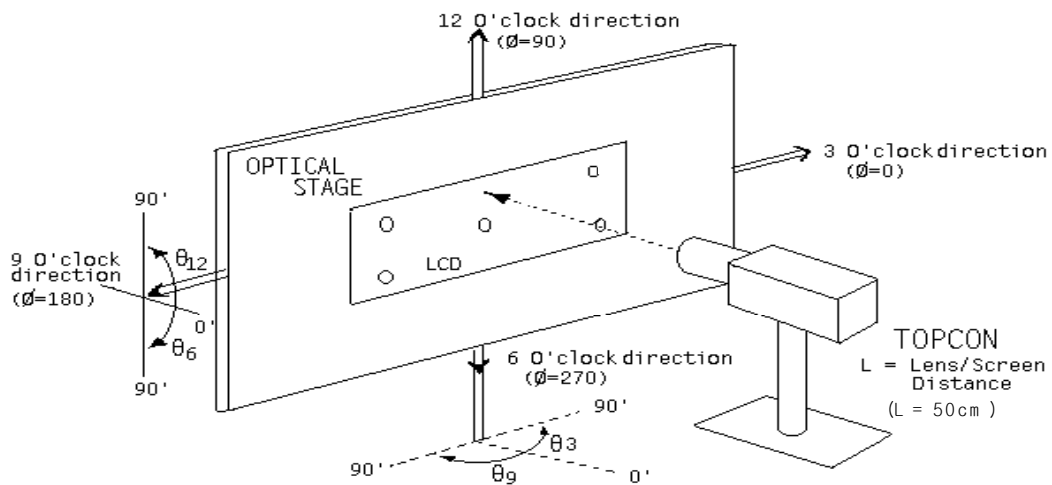

Figure 2. White Luminance and Uniformity Measurement Locations (9 points)

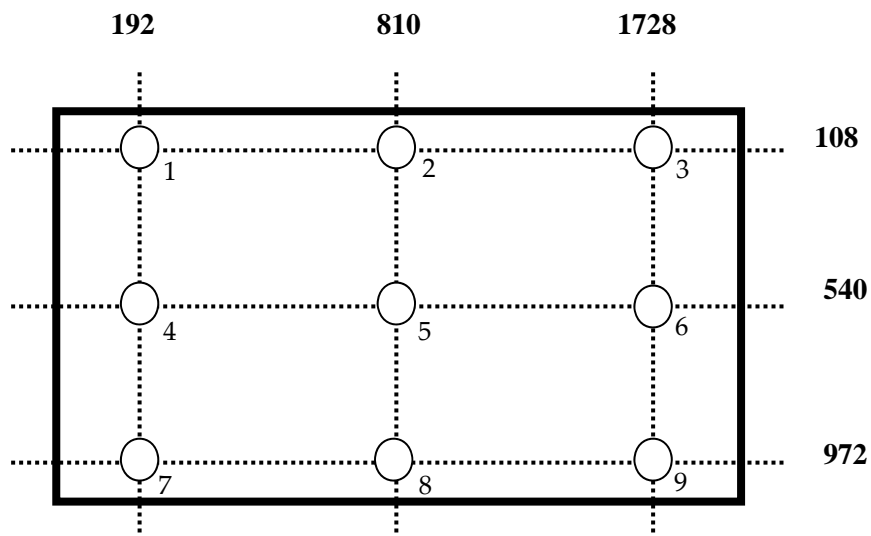
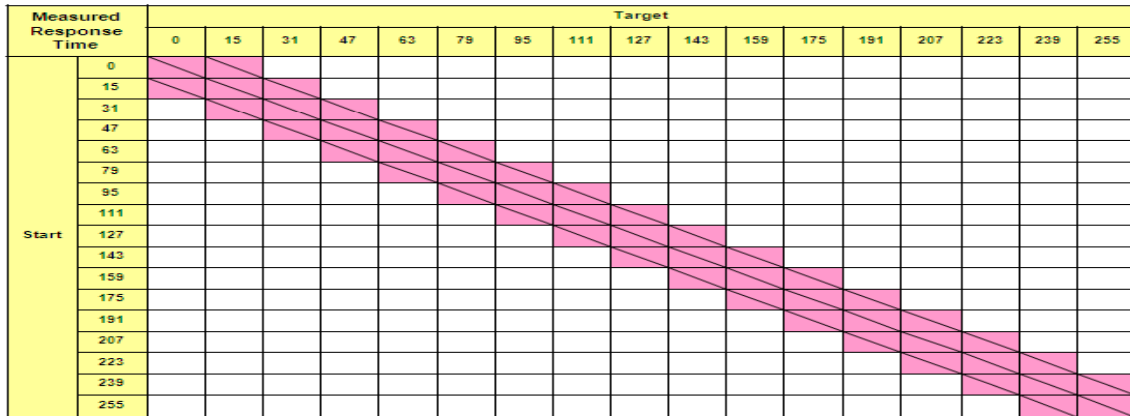
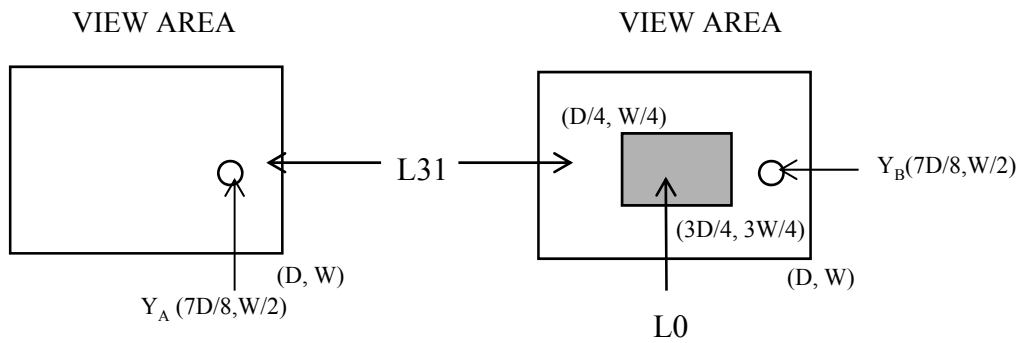

Figure 3. Response Time Testing

Figure 4. Cross Modulation Test Description

$$\text{Cross-Talk (\%)} = \left| \frac{Y_B - Y_A}{Y_A} \right| \times 100$$

Where: Y_A = Initial luminance of measured area (cd/m²)

Y_B = Subsequent luminance of measured area (cd/m²)

The location measured will be exactly the same in both patterns



PRODUCT GROUP

REV

ISSUE DATE

TFT- LCD PRODUCT

Rev.0

Jan. 13. 14'

SPEC. NUMBER

SPEC. TITLE

PAGE

MV238FHM-N10 Preliminary Product Specification_Rev.0

29 OF30

Figure 5. TFT-LCD Module Outline Dimensions (Front view)

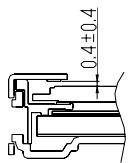
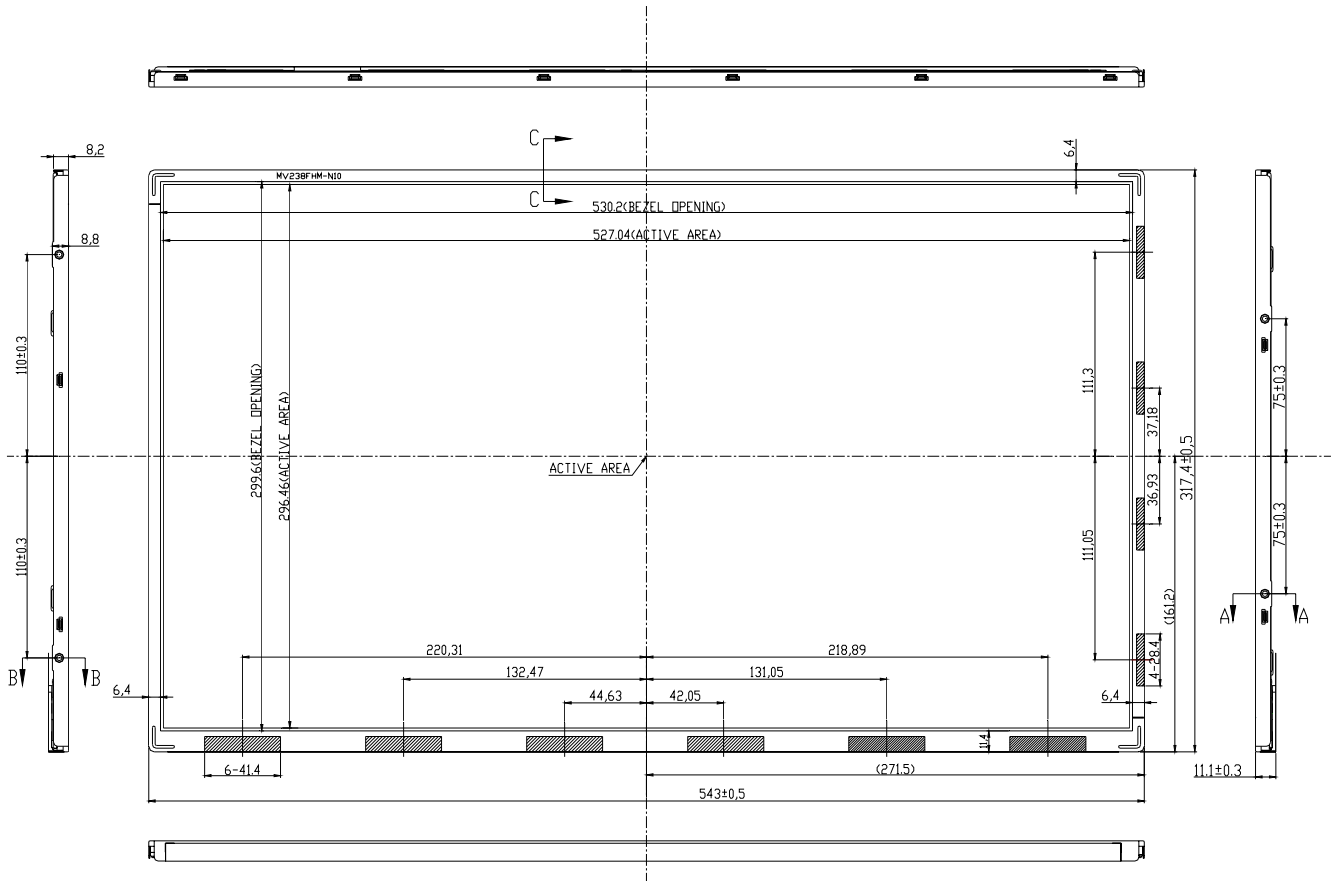

SECTION A-A
SCALE 5/1

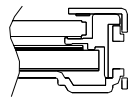

SECTION B-B
SCALE 5/1

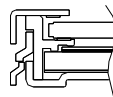

SECTION C-C
SCALE 5/1

NOTE:

- 1/F CONNECTOR SPECIFICATION IS100-L300-C23(UJU)
2. LED CONNECTOR SPECIFICATION 3708K-006N-00L(ENTERY)
3. Torque of userhole:3.0~4.0kgf-cm.
4. Tilt and partial disposition tolerance of display area as following:
(1) Y-direction: |A-B| ≤ 1.4
(2) X-direction: |C-D| ≤ 1.4

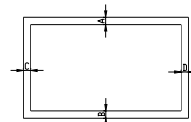

5. Unspecified tolerances to be ±0.5mm.
6. The CDF area is weak & sensitive, so don't press the CDF area.

 京东方 BOE	PRODUCT GROUP	REV	ISSUE DATE
	TFT- LCD PRODUCT	Rev.0	Jan. 13. 14'
SPEC. NUMBER	SPEC. TITLE MV238FHM-N10 Preliminary Product Specification_Rev.0		PAGE 30 OF30

Figure 6. TFT-LCD Module Outline Dimensions (Rear view)

