



**PROPRIETARY NOTE**

THIS SPECIFICATION IS THE PROPERTY OF BOE DT AND SHALL NOT BE REPRODUCED OR COPIED WITHOUT THE WRITTEN PERMISSION OF BOE DT AND MUST BE RETURNED TO BOE DT UPON ITS REQUEST

## Product Specification

# MODEL: HM236WU1-300

BN07-01169A	
Approved by	
Date	

## BEIJING BOE Display TECHNOLOGY

SPEC. NUMBER S	PRODUCT GROUP TFT-LCD	Rev.A	ISSUE DATE 2013. 04. 22	PAGE 1 OF 30
-------------------	--------------------------	-------	----------------------------	-----------------





京东方  
BOE

PRODUCT GROUP

REV

ISSUE DATE

TFT- LCD PRODUCT

A

2013.04.22

## Contents

No.	Item	Page
1.0	General Description	4
2.0	Absolute Maximum Ratings	6
3.0	Electrical Specifications	7
4.0	Optical Specifications	9
5.0	Interface Connection	11
6.0	Signal Timing Specifications	15
7.0	Signal Timing Waveforms of Interface Signal	17
8.0	Input Signals, Display Colors & Gray Scale of Colors	19
9.0	Power Sequence	20
10.0	Mechanical Characteristics	21
11.0	Reliability Test	22
12.0	Handling& Cautions	23
13.0	Product Serial Number	24
14.0	Packing	25
15.0	Appendix	27

SPEC. NUMBER  
S

SPEC. TITLE  
HM236WU1-300 Product Specification

PAGE  
3 OF 30

## 1.0 GENERAL DESCRIPTION

### 1.1 Introduction

HM236WU1-300 is a color active matrix TFT LCD module using amorphous silicon TFT's (Thin Film Transistors) as an active switching devices. This module has a 23.6 inch diagonally measured active area with FHD resolutions (1920 horizontal by 1080 vertical pixel array). Each pixel is divided into RED, GREEN, BLUE dots which are arranged in vertical stripe and this module can display 16.7M colors. The TFT-LCD panel used for this module is adapted for a low reflection and higher color type.

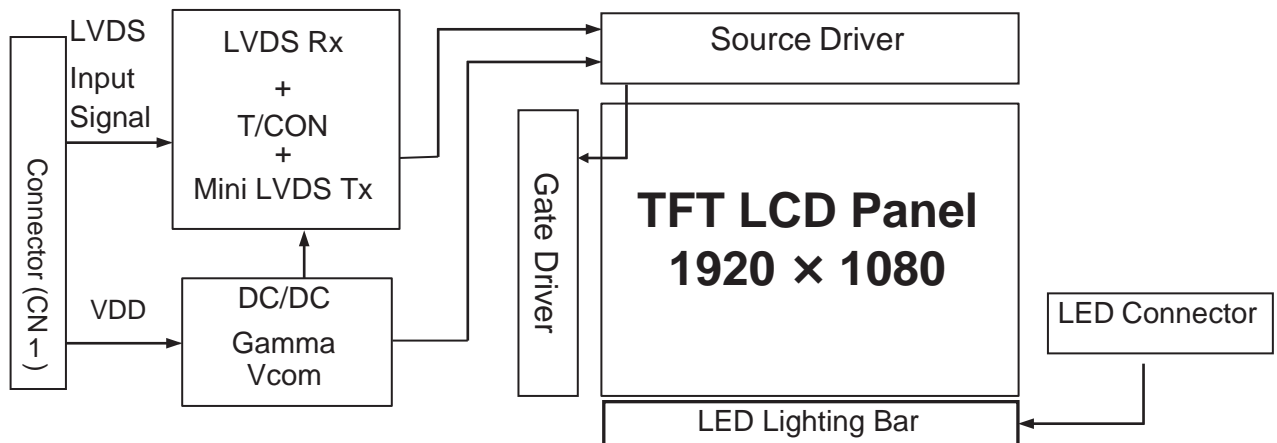

### 1.2 Features

- LVDS Interface with 2 pixel / clock
- High-speed response
- 6-bit (Hi-FRC) color depth, display 16. 7M colors
- Incorporated edge type back-light (LED)
- High luminance and contrast ratio, low reflection and wide viewing angle
- DE (Data Enable) only
- RoHS/Halogen Free
- TCO 6.0 , E/S 6.0 compliant
- Gamma Correction



# PRODUCT GROUP

REV

ISSUE DATE

TFT- LCD PRODUCT

A

2013.04.22

### 1.3 Application

- Desktop Type of PC & Workstation Use
- Slim-Size Display for Stand-alone Monitor
- Display Terminals for Control System
- Monitors for Process Controller

### 1.4 General Specification

The followings are general specifications at the model HM236WU1-300.

<Table 1. General Specifications>

Parameter	Specification	Unit	Remarks
Active area	521.28(H) × 293.22(V)	mm	
Number of pixels	1920(H) × 1080(V)	pixels	
Pixel pitch	0.2715(H) × 0.2715(V)	mm	
Pixel arrangement	RGB Vertical stripe		
Display colors	16.7M	colors	
Display mode	Normally White		
Dimensional outline	544.8(H) × 320.5(V) × 9.6(D) typ.	mm	
Weight	2200 (Typ.)	g	
Surface Treatment	Haze 25%, 3H		
Back-light	Lower edge side, 1-LED Lighting Bar type		Note 1
Power Consumption	$P_D$ : 5.5W (max)		
	$P_{BL}$ : 17.9W (max)		Note 2
	$P_{total}$ : 23.4 (max)		

Notes : 1. LED Lighting Bar (4\*input pins)

2.  $P_{LED}$ =Input pins\* VPIN×IPIN

SPEC. NUMBER  
S

SPEC. TITLE  
HM236WU1-300 Product Specification

PAGE  
5 OF 30

## 2.0 ABSOLUTE MAXIMUM RATINGS

The followings are maximum values which, if exceed, may cause faulty operation or damage to the unit. The operational and non-operational maximum voltage and current values are listed in Table 2.

< Table 2. Absolute Maximum Ratings >

[VSS=GND=0V]

Parameter	Symbol	Min.	Max.	Unit	Remarks
Power Supply Voltage	$V_{DD}$	-0.3	6.0	V	Ta = 25 ?
Logic Supply Voltage	$V_{IN}$	VSS-0.3	$V_{DD}+0.3$	V	
LED Light Bar Current Per Input Pin	IPIN	-	125	mA	
LED Light Bar Voltage Per Input Pin	VPIN	-	37.4	V	
Operating Temperature	$T_{OP}$	0	+50	?	1)
Storage Temperature	$T_{ST}$	-20	+60	?	1)

Note : 1) Temperature and relative humidity range are shown in the figure below.  
Wet bulb temperature should be 39 °C max. and no condensation of water.

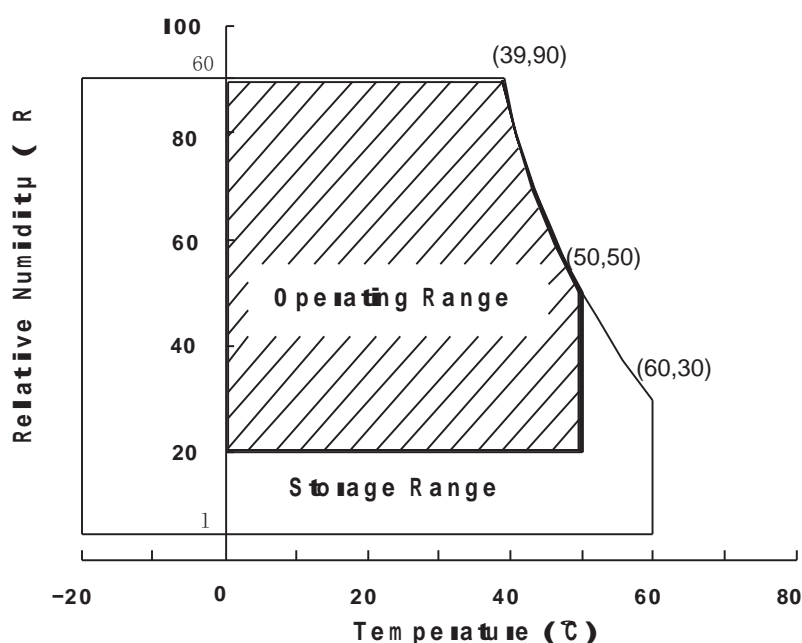

### 3.0 ELECTRICAL SPECIFICATIONS

#### 3.1 Electrical Specifications

&lt; Table 3. Electrical specifications &gt;

[Ta =25±2 ?]

Parameter		Min.	Typ.	Max.	Unit	Remarks
Power Supply Voltage	V <sub>DD</sub>	4.5	5.0	5.5	V	Note1
Power Supply Current	I <sub>DD</sub>	-	900	1100	mA	
In-Rush Current	I <sub>RUSH</sub>	-	2.0	3.0	A	Note 2
Permissible Input Ripple Voltage	V <sub>RF</sub>	-	-	300	mV	V <sub>DD</sub> = 5.0V
High Level Differential Input Threshold Voltage	V <sub>IH</sub>	-	-	+100	mV	
Low Level Differential Input Threshold Voltage	V <sub>IL</sub>	-100	-	-	mV	
Differential input voltage	V <sub>ID</sub>	200	-	600	mV	
Differential input common mode voltage	V <sub>cm</sub>	1.0	1.2	1.5		V <sub>IH</sub> =100mV, V <sub>IL</sub> =-100mV
Power Consumption	P <sub>D</sub>	-	4.5	5.5	W	
	P <sub>BL</sub>	15.9	16.9	17.9	W	Note 3
	P <sub>total</sub>	-	21.4	23.4	W	

Notes 1. The supply voltage is measured and specified at the interface connector of LCM.

The current draw and power consumption specified is for VDD=5.0V,

Frame rate=75Hz,Clock frequency = 92.9 MHz.

Test Pattern of power supply current

a) Typ : Color Test

b) Max : Skip Subpixel255

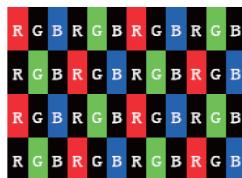

2. Duration of rush current is about 2 ms and rising time of VDD is 520 μs ± 20%

3. Calculated value for reference (Input pins\*VPIN × IPIN) excluding inverter loss.

SPEC. NUMBER

S

SPEC. TITLE

HM236WU1-300 Product Specification

PAGE

7 OF 30

### 3.2 Backlight Unit

< Table 4. LED Backlight Unit >

Parameter		Min.	Typ.	Max.	Unit	Remarks
LED Light Bar Input Voltage Per Input Pin	VPIN	33	35.2	37.4	V	Duty 100%
LED Light Bar Input Current Per Input Pin	IPIN	-	120	-	mA	Note1,2,
LED Power Consumption	P <sub>BL</sub>	15.9	16.9	17.9	W	Note 3
LED Life-Time	-	30,000	-		Hrs	Note 4

Note 1. There are one light bar ,and the specified current is input LED chip 100% duty current

2. The sense current of each input pin is 100mA

3.  $P_{BL}=4 \text{ Input pins} \times V_{PIN} \times I_{PIN}$

4. The lifetime is determined as the time at which luminance of LED become 50% of the initial brightness or not normal lighting at  $I_{PIN}=100\text{mA}$  on condition of continuous operating at  $25 \pm 2$  ?





# PRODUCT GROUP

REV

ISSUE DATE

TFT- LCD PRODUCT

A

2013.04.22

## 4.0 OPTICAL SPECIFICATION

### 4.1 Overview

The test of Optical specifications shall be measured in a dark room (ambient luminance  $\leq 1$  lux and temperature =  $25 \pm 2^\circ\text{C}$ ) with the equipment of Luminance meter system (Goniometer system and TOPCONE BM-5) and test unit shall be located at an approximate distance 50cm from the LCD surface at a viewing angle of 0 and 0 equal to  $0^\circ$ . We refer to  $0_{\theta=0}$  ( $=0_3$ ) as the 3 o'clock direction (the "right"),  $0_{\theta=90}$  ( $=0_{12}$ ) as the 12 o'clock direction ("upward"),  $0_{\theta=180}$  ( $=0_9$ ) as the 9 o'clock direction ("left") and  $0_{\theta=270}$  ( $=0_6$ ) as the 6 o'clock direction ("bottom"). While scanning  $\theta$  and/or  $\theta$ , the center of the measuring spot on the Display surface shall stay fixed. The measurement shall be executed after 30 minutes warm-up period. VDD shall be 5.0V +/- 10% at  $25^\circ\text{C}$ . Optimum viewing angle direction is 6 'clock.

### 4.2 Optical Specifications

[VDD = 5.0V, Frame rate = 60Hz, Clock = 74.25MHz,  $I_{BL} = 400\text{mA}$ ,  $T_a = 25 \pm 2^\circ\text{C}$ ]

Parameter		Symbol	Condition	Min.	Typ.	Max.	Unit	Remark
Viewing Angle	Horizontal	$\odot_3$	CR > 10	75	85	-	Deg.	Note 1
		$\odot_9$		75	85	-	Deg.	
	Vertical	$\odot_{12}$		70	80	-	Deg.	
		$\odot_6$		70	80	-	Deg.	
Luminance Contrast ratio		CR	$\odot = 0^\circ$ (Center) Normal Viewing Angle	700	1000			Note 2
Luminance of White		$Y_w$		250	300		cd/m <sup>2</sup>	Note 3
White luminance uniformity		AY		75	80		%	Note 4
Reproduction of color	White	$W_x$		0.283	0.313	0.343	-	Note 5
		$W_y$		0.299	0.329	0.359	-	
	Red	$R_x$		0.613	0.643	0.673	-	
		$R_y$		0.312	0.342	0.372	-	
	Green	$G_x$		0.287	0.317	0.347	-	
		$G_y$		0.598	0.628	0.658	-	
Blue	$B_x$	0.118		0.148	0.178	-		
	$B_y$	0.034	0.064	0.094	-			
Response Time	Rising	$T_r$		1.5	2.5	ms	Note 6	
	Falling	$T_f$		3.5	5.5	ms		
Cross Talk		CT		-	-	2.0	%	Note 7

SPEC. NUMBER  
S

SPEC. TITLE  
HM236WU1-300 Product Specification

PAGE  
9 OF 30



京东方  
BOE

PRODUCT GROUP

REV

ISSUE DATE

TFT- LCD PRODUCT

A

2013.04.22

**Note :**

1. Viewing angle is the angle at which the contrast ratio is greater than 10. The viewing are determined for the horizontal or 3, 9 o'clock direction and the vertical or 6, 12 o'clock direction with respect to the optical axis which is normal to the LCD surface.
2. Contrast measurements shall be made at viewing angle of  $\theta = 0^\circ$  and at the center of the LCD surface. Luminance shall be measured with all pixels in the view field set first to white, then to the dark (black) state. (See FIGURE 1 shown in Appendix)  
Luminance Contrast Ratio (CR) is defined mathematically.

$$CR = \frac{\text{Luminance when displaying a white raster}}{\text{Luminance when displaying a black raster}}$$

3. Center Luminance of white is defined as the LCD surface. Luminance shall be measured with all pixels in the view field set first to white. This measurement shall be taken at the locations shown in FIGURE 2 for a total of the measurements per display.
4. The White luminance uniformity on LCD surface is then expressed as :  
 $AY = (\text{Minimum Luminance of 9points} / \text{Maximum Luminance of 9points}) * 100$   
(See FIGURE 2 shown in Appendix).
5. The color chromaticity coordinates specified in Table 4. shall be calculated from the spectral data measured with all pixels first in red, green, blue and white. Measurements shall be made at the center of the panel.
6. The electro-optical response time measurements shall be made as FIGURE 3 shown in Appendix by switching the "data" input signal ON and OFF. The times needed for the luminance to change from 10% to 90% is Td, and 90% to 10% is Tr.
7. Cross-Talk of one area of the LCD surface by another shall be measured by comparing the luminance ( $Y_A$ ) of a 25mm diameter area, with all display pixels set to a gray level, to the luminance ( $Y_B$ ) of that same area when any adjacent area is driven dark. (See FIGURE 4 shown in Appendix).

SPEC. NUMBER  
S

SPEC. TITLE  
HM236WU1-300 Product Specification

PAGE  
10 OF 30

## 5.0 INTERFACE CONNECTION.

### 5.1 LED Light Bar Input Pin Assignment

< Table 1. LED Light Bar >

Pin No	Symbol	Description
1	IRLED1	LED current sense for string1
2	IRLED2	LED current sense for string2
3	VLED	LED power supply
4	VLED	LED power supply
5	IRLED3	LED current sense for string3
6	IRLED4	LED current sense for string4

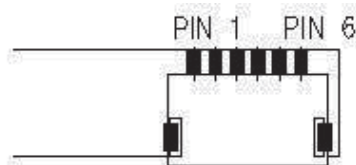

Figure1. Top View of LED Bar Connector

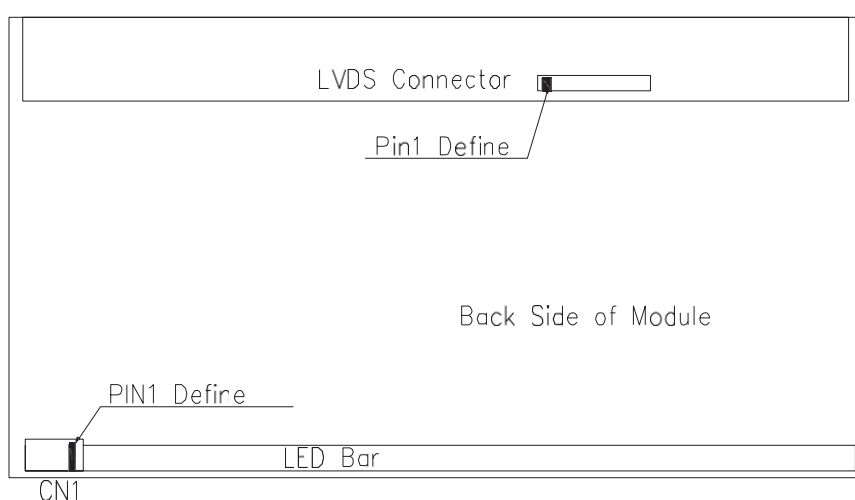

Figure2. Back Side of Module



# PRODUCT GROUP

REV

ISSUE DATE

TFT- LCD PRODUCT

A

2013.04.22

## 5.2 Module Input Signal & Power

- CN11 Module Side Connector : UJU IS100-L30R-C23or Equivalent  
User Side Connector : JAE FI-X30H or Equivalent

Pin No	Symbol	Function	Remark
1	RX00-	Negative Transmission data of Pixel 0 (ODD)	
2	RX00+	Positive Transmission data of Pixel 0 (ODD)	
3	RX01-	Negative Transmission data of Pixel 1 (ODD)	
4	RX01+	Positive Transmission data of Pixel 1 (ODD)	
5	RX02-	Negative Transmission data of Pixel 2 (ODD)	
6	RX02+	Positive Transmission data of Pixel 2 (ODD)	
7	GND	Power Ground	
8	RXOC-	Negative Transmission Clock (ODD)	
9	RXOC+	Positive Transmission Clock (ODD)	
10	RX03-	Negative Transmission data of Pixel 3 (ODD)	
11	RX03+	Positive Transmission data of Pixel 3 (ODD)	
12	RXE0-	Negative Transmission data of Pixel 0 (EVEN)	
13	RXE0+	Positive Transmission data of Pixel 0 (EVEN)	
14	GND	Power Ground	
15	RXE1-	Negative Transmission data of Pixel 1 (EVEN)	
16	RXE1+	Positive Transmission data of Pixel 1 (EVEN)	
17	GNG	Power Ground	
18	RXE2-	Negative Transmission data of Pixel 2 (EVEN)	
19	RXE2+	Positive Transmission data of Pixel 2 (EVEN)	
20	RXEC-	Negative Transmission Clock (EVEN)	
21	RXEC+	Positive Transmission Clock (EVEN)	
22	RXE3-	Negative Transmission data of Pixel 3 (EVEN)	
23	RXE3+	Positive Transmission data of Pixel 3 (EVEN)	
24	GND	Power Ground	Note 1
25	NC	No. Connection	
26	NC		
27	NC		
28	VDD	Power Supply: +5V	
29	VDD		
30	VDD		

Note 1 : This pin should be connected with GND.

SPEC. NUMBER  
S

SPEC. TITLE  
HM236WU1-300 Product Specification

PAGE  
12 OF 30



PRODUCT GROUP

REV

ISSUE DATE

TFT- LCD PRODUCT

A

2013.04.22

5.3 LVDS Interface (Tx; THC63LVDF83A or Equivalent)

	Input Signal	Transmitter		Interface		HM236WU1-100 (CN11)	Remark
		Pin No.	Pin No.	System (Tx)	TFT-LCD (Rx)	Pin No.	
LVDS	OR0	51	48 47	OUT0- OUT0+	RXO0- RXO0+	1	
	OR1	52					
	OR2	54					
	OR3	55					
	OR4	56				2	
	OR5	3					
	OG0	4	46 45	OUT1- OUT1+	RXO1- RXO1+	3	
	OG1	6					
	OG2	7					
	OG3	11					
	OG4	12				4	
	OG5	14					
	OB0	15	42 41	OUT2- OUT2+	RXO2- RXO2+	5	
	OB1	19					
	OB2	20					
	OB3	22					
	OB4	23				6	
	OB5	24					
	Hsync	27	8	CLK OUT- CLK OUT+	RXO CLK- RXO CLK+		
	Vsync	28					
DE	30	9					
MCLK	31		40 39				
OR6	50	38 37	OUT3- OUT3+	RXO3- RXO3+	10		
OR7	2						
OG6	8						
OG7	10						
OB6	16						
OB7	18						
RSVD	25				11		

SPEC. NUMBER  
S

SPEC. TITLE  
HM236WU1-300 Product Specification

PAGE  
13 OF 30

### 5.4 Data Input Format

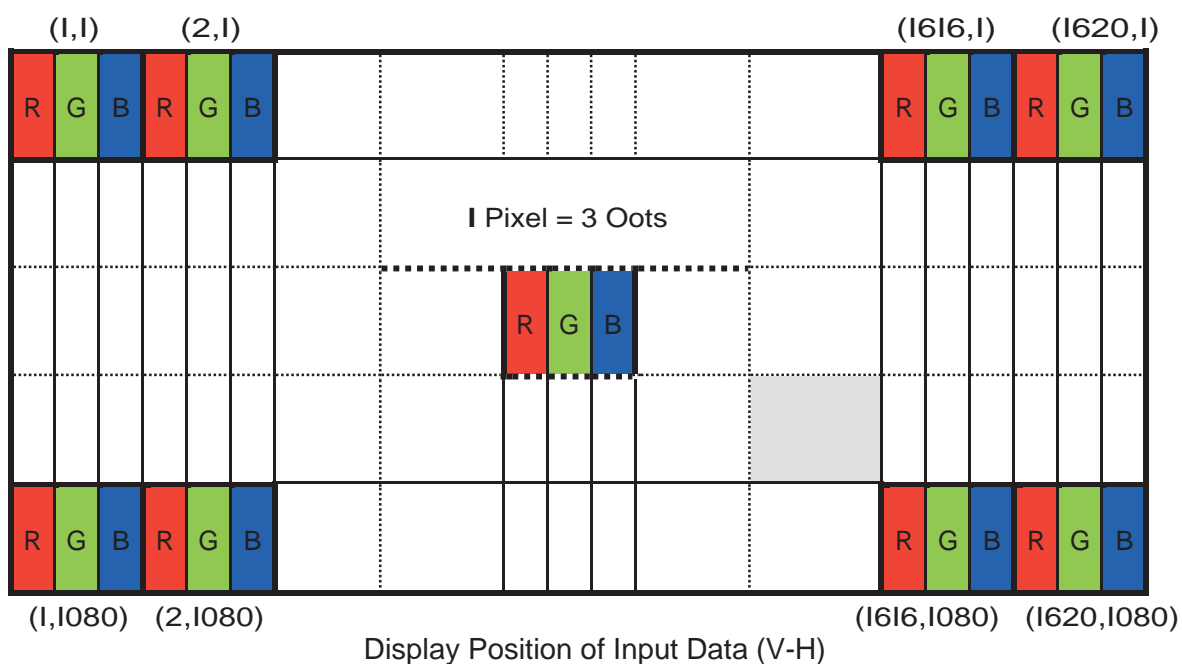

## 6.0 SIGNAL TIMING SPECIFICATION

6.1 The HM236WU1-300 is operated by the DE only.

Item		Symbols	Min	Typ	Max	Unit
Clock	Frequency	1/Tc	58.54	74.25	98	MHz
	High Time	Tch	-	4/7Tc	-	
	Low Time	Tcl	-	4/7Tc	-	
Frame Period		Tv	1115	1126	1136	lines
			50	60	75	Hz
			20	16.7	13.3	ms
Vertical Display Period		Tvd	-	1080	-	lines
One line Scanning Period		Th	1050	1100	1150	clocks
Horizontal Display Period		Thd	960	960	960	clocks
Modulating frequency of Input clock during SSC		Flvmod	10	-	200	KHz
Maximum deviation of Input clock frequency During SSC		Flvdev	-3	-	+3	%
Cycle to Cycle jitter		Tcy-cy	-	-	200	ps

## 6.2 LVDS Rx Interface Timing Parameter

The specification of the LVDS Rx interface timing parameter is shown in Table 4.

<Table 4. LVDS Rx Interface Timing Specification>

Item	Symbol	Min	Typ	Max	Unit
CLKIN Period	tRCIP	10.20	13.47	17.08	nsec
Input Data 0	tRIP1	-0.4	0.0	+0.4	nsec
Input Data 1	tRIP0	tRCIP/7-0.4	tRCIP/7	tRCIP/7+0.4	nsec
Input Data 2	tRIP6	2 × tRCIP/7-0.4	2 × tRCIP/7	2 × tRCIP/7+0.4	nsec
Input Data 3	tRIP5	3 × tRCIP/7-0.4	3 × tRCIP/7	3 × tRCIP/7+0.4	nsec
Input Data 4	tRIP4	4 × tRCIP/7-0.4	4 × tRCIP/7	4 × tRCIP/7+0.4	nsec
Input Data 5	tRIP3	5 × tRCIP/7-0.4	5 × tRCIP/7	5 × tRCIP/7+0.4	nsec
Input Data 6	tRIP2	6 × tRCIP/7-0.4	6 × tRCIP/7	6 × tRCIP/7+0.4	nsec

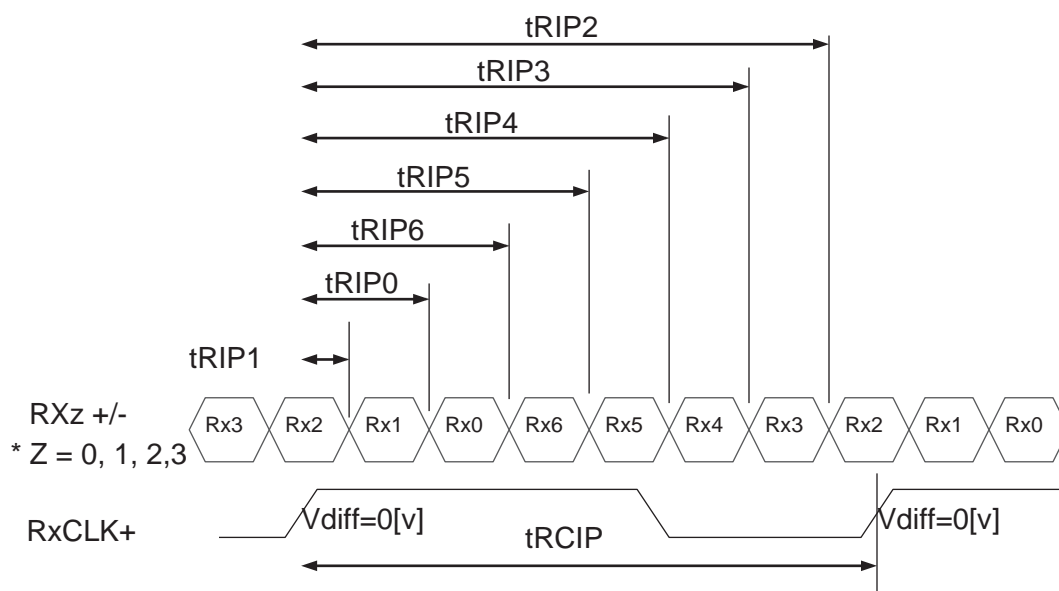

$$* V_{diff} = (Rx_z^+) - (Rx_z^-), \dots, (RxCLK^+) - (RxCLK^-)$$



## 7.0 SIGNAL TIMING WAVEFORMS OF INTERFACE SIGNAL

### 7.1 Sync Timing Waveforms

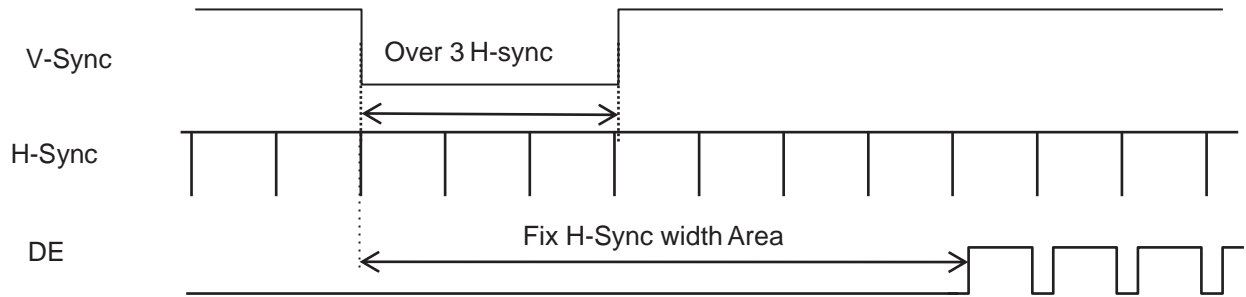

- 1) Need over 3 H-sync during V-Sync Low
- 2) Fix H-Sync width from V-Sync falling edge to first rising edge

### 7.2 Vertical Timing Waveforms

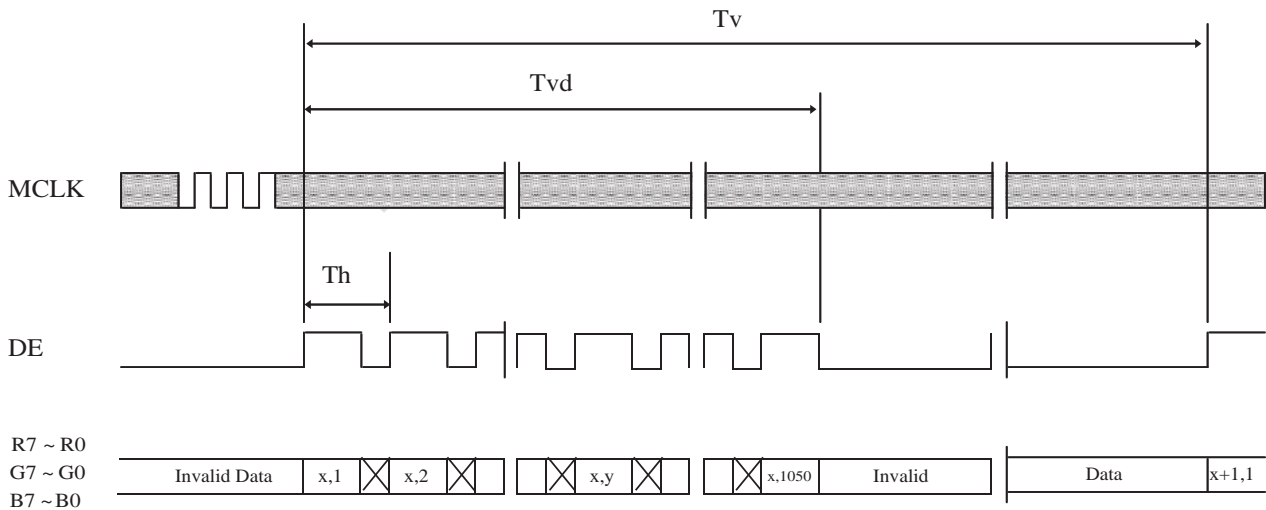

### 7.3 Horizontal Timing Waveforms

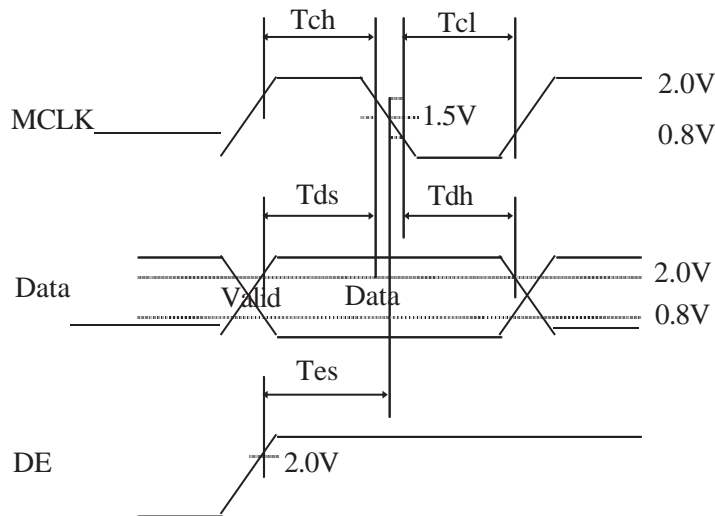
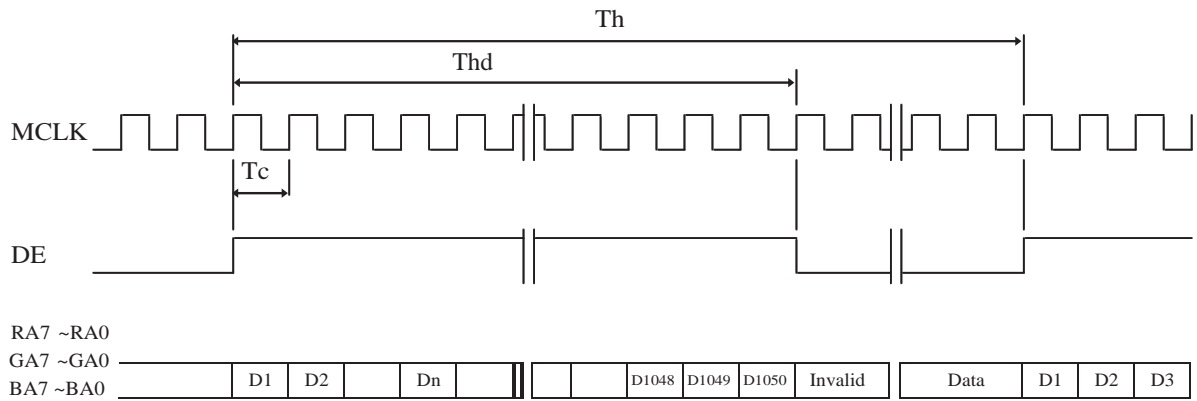



# PRODUCT GROUP

REV

ISSUE DATE

TFT- LCD PRODUCT

A

2013.04.22

## 8.0 INPUT SIGNALS, BASIC DISPLAY COLORS & GRAY SCALE OF COLORS

Color & Gray Scale		RED DATA								GREEN DATA								BLUE DATA							
		R7	R6	R5	R4	R3	R2	R1	R0	G7	G6	G5	G4	G3	G2	G1	G0	B7	B6	B5	B4	B3	B2	B1	B0
Basic Colors	Black	0	0	0	0	0	0	0	0	0	0	0	0	0	0	0	0	0	0	0	0	0	0	0	0
	Blue	0	0	0	0	0	0	0	0	0	0	0	0	0	0	0	0	1	1	1	1	1	1	1	1
	Green	0	0	0	0	0	0	0	0	1	1	1	1	1	1	1	1	0	0	0	0	0	0	0	0
	Cyan	0	0	0	0	0	0	0	0	1	1	1	1	1	1	1	1	1	1	1	1	1	1	1	1
	Red	1	1	1	1	1	1	1	1	0	0	0	0	0	0	0	0	0	0	0	0	0	0	0	0
	Magenta	1	1	1	1	1	1	1	1	0	0	0	0	0	0	0	0	1	1	1	1	1	1	1	1
	Yellow	1	1	1	1	1	1	1	1	1	1	1	1	1	1	1	1	0	0	0	0	0	0	0	0
	White	1	1	1	1	1	1	1	1	1	1	1	1	1	1	1	1	1	1	1	1	1	1	1	1
Gray Scale of RED	Black	0	0	0	0	0	0	0	0	0	0	0	0	0	0	0	0	0	0	0	0	0	0	0	0
	A	0	0	0	0	0	0	0	1	0	0	0	0	0	0	0	0	0	0	0	0	0	0	0	0
	Darker	0	0	0	0	0	0	1	0	0	0	0	0	0	0	0	0	0	0	0	0	0	0	0	0
	A	‡								‡								‡							
	A	\$								\$								\$							
	Brighter	1	1	1	1	1	1	0	1	0	0	0	0	0	0	0	0	0	0	0	0	0	0	0	0
	A	1	1	1	1	1	1	1	0	0	0	0	0	0	0	0	0	0	0	0	0	0	0	0	0
	Red	1	1	1	1	1	1	1	1	0	0	0	0	0	0	0	0	0	0	0	0	0	0	0	0
Gray Scale of GREEN	Black	0	0	0	0	0	0	0	0	0	0	0	0	0	0	0	0	0	0	0	0	0	0	0	0
	A	0	0	0	0	0	0	0	0	0	0	0	0	0	0	0	1	0	0	0	0	0	0	0	0
	Darker	0	0	0	0	0	0	0	0	0	0	0	0	0	0	1	0	0	0	0	0	0	0	0	0
	A	‡								‡								‡							
	A	\$								\$								\$							
	Brighter	0	0	0	0	0	0	0	0	1	1	1	1	1	1	0	1	0	0	0	0	0	0	0	0
	A	0	0	0	0	0	0	0	0	1	1	1	1	1	1	1	0	0	0	0	0	0	0	0	0
	Green	0	0	0	0	0	0	0	0	1	1	1	1	1	1	1	1	0	0	0	0	0	0	0	0
Gray Scale of BLUE	Black	0	0	0	0	0	0	0	0	0	0	0	0	0	0	0	0	0	0	0	0	0	0	0	0
	A	0	0	0	0	0	0	0	0	0	0	0	0	0	0	0	0	0	0	0	0	0	0	0	1
	Darker	0	0	0	0	0	0	0	0	0	0	0	0	0	0	0	0	0	0	0	0	0	0	1	0
	A	‡								‡								‡							
	A	\$								\$								\$							
	Brighter	0	0	0	0	0	0	0	0	0	0	0	0	0	0	0	0	1	1	1	1	1	1	0	1
	A	0	0	0	0	0	0	0	0	0	0	0	0	0	0	0	0	1	1	1	1	1	1	1	0
	Blue	0	0	0	0	0	0	0	0	0	0	0	0	0	0	0	0	1	1	1	1	1	1	1	1
Gray Scale of WHITE	Black	0	0	0	0	0	0	0	0	0	0	0	0	0	0	0	0	0	0	0	0	0	0	0	0
	A	0	0	0	0	0	0	0	1	0	0	0	0	0	0	0	1	0	0	0	0	0	0	0	1
	Darker	0	0	0	0	0	0	1	0	0	0	0	0	0	0	1	0	0	0	0	0	0	0	1	0
	A	‡								‡								‡							
	A	\$								\$								\$							
	Brighter	1	1	1	1	1	1	0	1	1	1	1	1	1	1	0	1	1	1	1	1	1	1	0	1
	A	1	1	1	1	1	1	1	0	1	1	1	1	1	1	1	0	1	1	1	1	1	1	1	0
	White	1	1	1	1	1	1	1	1	1	1	1	1	1	1	1	1	1	1	1	1	1	1	1	1

SPEC. NUMBER  
S

SPEC. TITLE  
HM236WU1-300 Product Specification

PAGE  
19 OF 30

## 9.0 POWER SEQUENCE

To prevent a latch-up or DC operation of the LCD module, the power on/off sequence shall be as shown in below

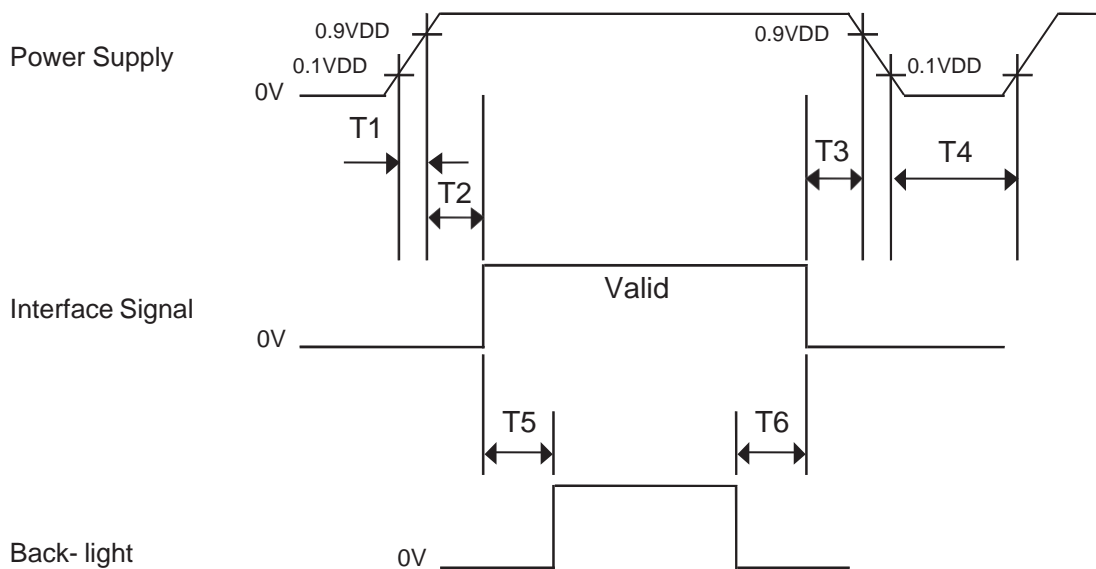

- 0.5 ms  $\checkmark$  T1  $\square$  10 ms
- 0  $\square$  T2  $\square$  50 ms
- 0  $\checkmark$  T3  $\square$  50 ms
- 1 sec  $\square$  T4
- 200 ms  $\square$  T5
- 200 ms  $\square$  T6

### Notes:

1. When the power supply VDD is 0V, keep the level of input signals on the low or keep high impedance.
2. Do not keep the interface signal high impedance when power is on.
3. Back Light must be turn on after power for logic and interface signal are valid.

## 10.0 MECHANICAL CHARACTERISTICS

### 10.1 Dimensional Requirements

FIGURE 6 (located in Appendix) shows mechanical outlines for the model HM236WU1-100. Other parameters are shown in Table 5.

<Table 5. Dimensional Parameters>

Parameter	Specification	Unit
Dimensional outline	544.8(H) × 320.5(V) × 9.6(D) typ	mm
Weight	2060(typ)	gram
Active area	521.28 (H) × 293.22 (V)	mm
Pixel pitch	0.2715 (H) × 0.2715 (V)	mm
Number of pixels	1920 (H) × 1080 (V) (1 pixel = R + G + B dots)	pixels
Back-light	Lower edge side, 1-LED Lighting Bar type	

### 10.2 Mounting

See FIGURE 5. (shown in Appendix)

### 10.3 Anti-Glare and Polarizer Hardness.

The surface of the LCD has an anti-glare coating to minimize reflection and a coating to reduce scratching.

### 10.4 Light Leakage

There shall not be visible light from the back-lighting system around the edges of the screen as seen from a distance 50cm from the screen with an overhead light level of 350lux.

## 11.0 RELIABILITY TEST

The Reliability test items and its conditions are shown in below.

<Table 6. Reliability Test Parameters >

No	Test Items	Conditions	
1	High temperature storage test	Ta = 60 ℃, 240 hrs	
2	Low temperature storage test	Ta = -20 ℃, 240 hrs	
3	High temperature & high humidity operation test	Ta = 50 ℃, 80%RH, 240hrs	
4	High temperature operation test	Ta = 50 ℃, 240hrs	
5	Low temperature operation test	Ta = 0 ℃, 240hrs	
6	Thermal shock	Ta = -20 ℃ — 60 ℃ (0.5 hr), 100 cycle	
7	Vibration test (non-operating)	Frequency	Random, 10 ~ 300 Hz, 30 min/Axis
		Gravity / AMP	1.5 Grms
		Period	X, Y, Z 30 min
8	Shock test (non-operating)	Gravity	50G
		Pulse width	11msec, sine wave
		Direction	±X, ±Y, ±Z Once for each
9	Electro-static discharge test (non-operating)	Air : 150 pF, 330K, 15 KV Contact : 150 pF, 330K, 8 KV	



PRODUCT GROUP

REV

ISSUE DATE

TFT- LCD PRODUCT

A

2013.04.22

12.0 HANDLING & CAUTIONS

(1) Cautions when taking out the module

- Pick the pouch only, when taking out module from a shipping package.

(2) Cautions for handling the module

- As the electrostatic discharges may break the LCD module, handle the LCD module with care. Peel a protection sheet off from the LCD panel surface as slowly as possible.
- As the LCD panel and back - light element are made from fragile glass material, impulse and pressure to the LCD module should be avoided.
- As the surface of the polarizer is very soft and easily scratched, use a soft dry cloth without chemicals for cleaning.
- Do not pull the interface connector in or out while the LCD module is operating.
- Put the module display side down on a flat horizontal plane.
- Handle connectors and cables with care.

(3) Cautions for the operation

- When the module is operating, do not lose CLK, ENAB signals. If any one of these signals is lost, the LCD panel would be damaged.
- Obey the supply voltage sequence. If wrong sequence is applied, the module would be damaged.

(4) Cautions for the atmosphere

- Dew drop atmosphere should be avoided.
- Do not store and/or operate the LCD module in a high temperature and/or humidity atmosphere. Storage in an electro-conductive polymer packing pouch and under relatively low temperature atmosphere is recommended.

(5) Cautions for the module characteristics

- Do not apply fixed pattern data signal to the LCD module at product aging.
- Applying fixed pattern for a long time may cause image sticking.

(6) Other cautions

- Do not disassemble and/or re-assemble LCD module.
- Do not re-adjust variable resistor or switch etc.
- When returning the module for repair or etc., Please pack the module not to be broken. We recommend to use the original shipping packages.

SPEC. NUMBER

S

SPEC. TITLE

HM236WU1-300 Product Specification

PAGE

23 OF 30



PRODUCT GROUP

REV

ISSUE DATE

TFT- LCD PRODUCT

A

2013.04.22

13.0 PRODUCT SERIAL NUMBER

HM236WU1-300

XXXXXXXXXXXXXXXXXXXX

XXXXXXXXXXXXXXXXXXXX

MADE IN CHINA XXXXXXXXXXXXXXXXXXXXXXX



- 1. Control Number
- 2. Rank / Grade
- 3. Line Classification
- 4. Year (2001 : 01, 2002 : 02, ...)
- 5. Month (1,2,3, ... , 9, X, Y, Z)
- 6. Internal Use
- 7. Serial Number



**BB – D91300– B – D – B4 – L– B4 – 5 – 5AR – 1234**  
 (1) (2) (3) (4) (5) (6) (7) (8) (9) (10)

- 1.Supplier Code    2.Model code    3.Source Driver IC Code    4.Gate Driver IC Code
- 5.Cell Location    6.LED Bar supplier    7.Module Location
- 8.Module Line Code Follow OLB    9.Date Code    10.Serial No

SPEC. NUMBER S	SPEC. TITLE HM236WU1-300 Product Specification	PAGE 24 OF 30
-------------------	---	------------------



## 14.0 Packing

### 14.1 Packing Order

Put pad into the box

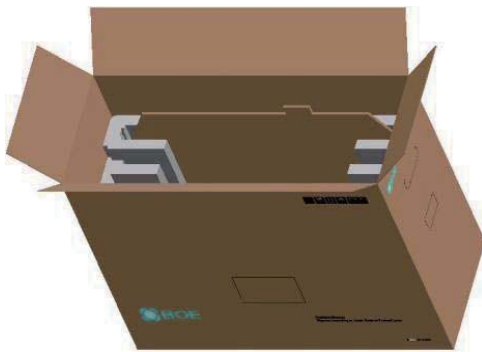

Place the modules bundled by packing bag in the box, 8pcs module per box, place a cover on the top of the box

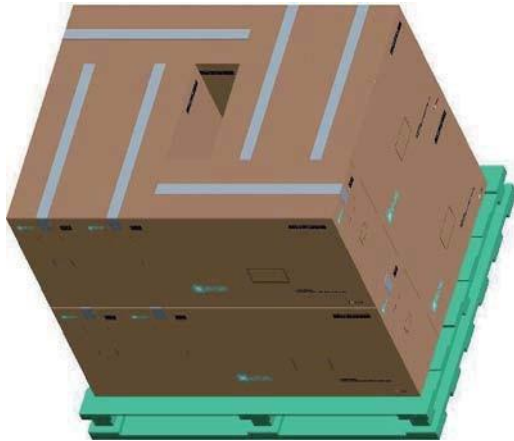
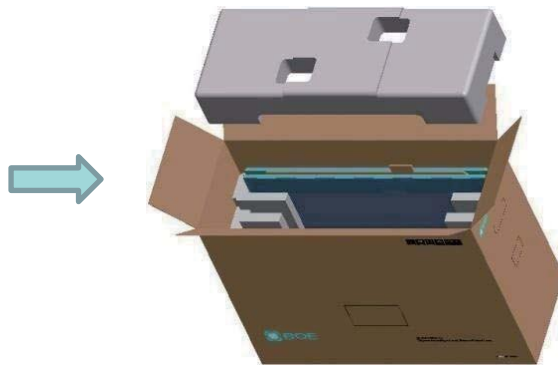

12ea box per pallet

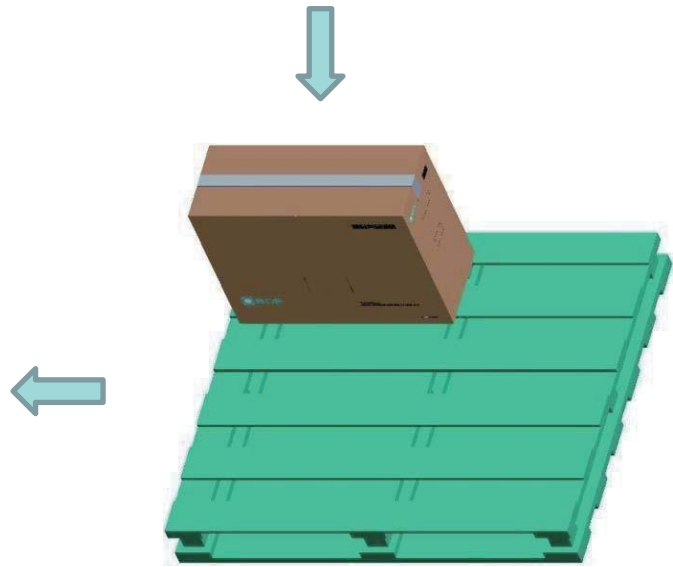

After sealing the box, put the box on the pallet



# PRODUCT GROUP

REV

ISSUE DATE

TFT- LCD PRODUCT

A

2013.04.22

## 14.2 Packing Note

- Box Dimension : 233mm(W) × 613mm(L) × 445mm(H)
- Package Quantity in one Box : 8 pcs

## 14.3 Box label

- Label Size : 108 mm (L) × 56 mm (W)
- Contents  
 Model : HM236WU1-300  
 Q`ty : Module 8 Q`ty in one box  
 Serial No. : Box Serial No. See next page for detail description.  
 Date : Packing Date



**MODEL :** HM236WU1-300      **Q'TY :** 8

**SERIAL NO. :** 00000000000000      **DATE :** 20XX.X.XX



• QAA0330000268 •

5940



(QA)

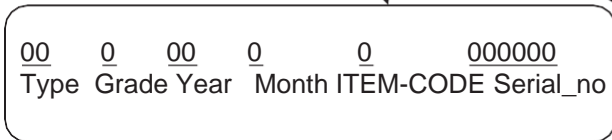

Internal Use

RoHS Mark

SPEC. NUMBER  
S

SPEC. TITLE  
HM236WU1-300 Product Specification

PAGE  
26 OF 30

## 15.0 APPENDIX

Figure 1. Measurement Set Up

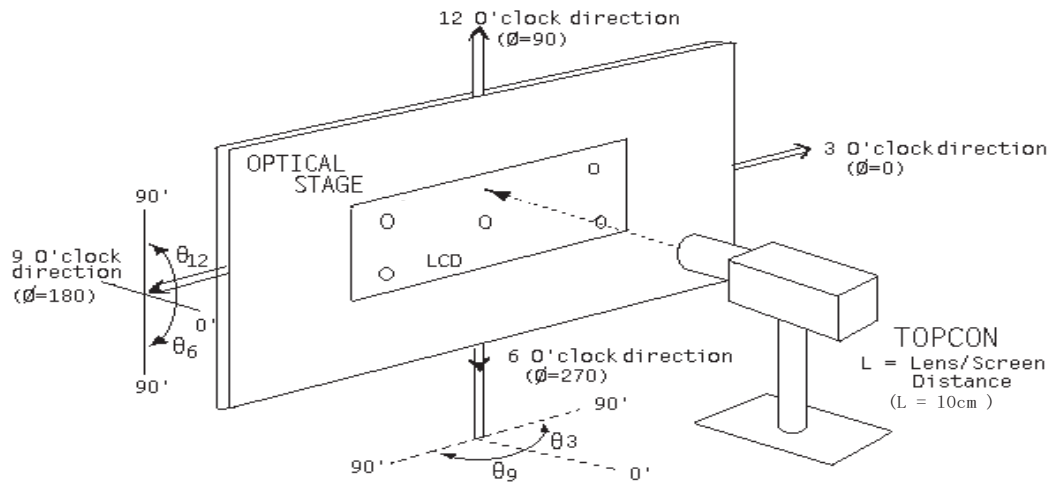
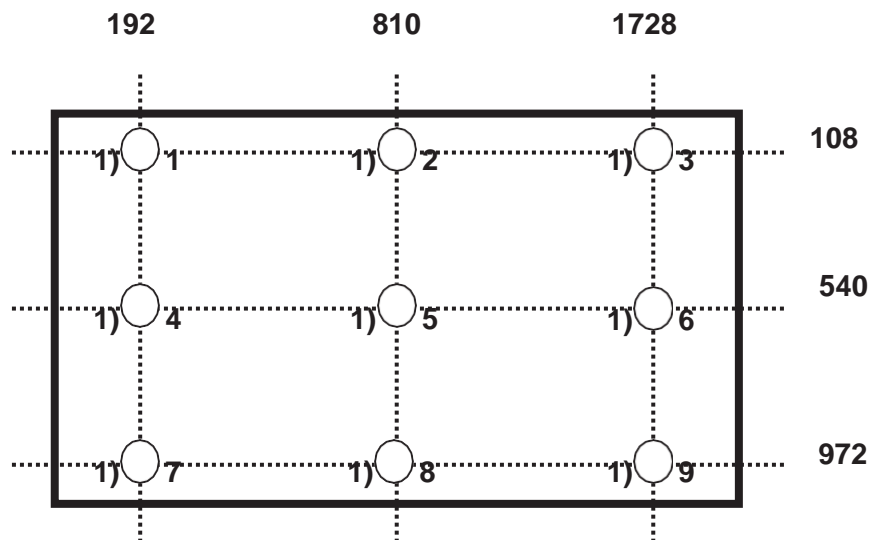
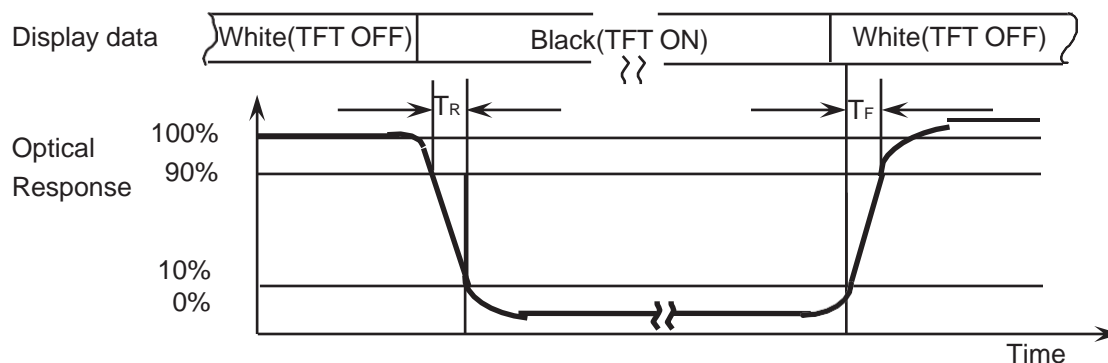
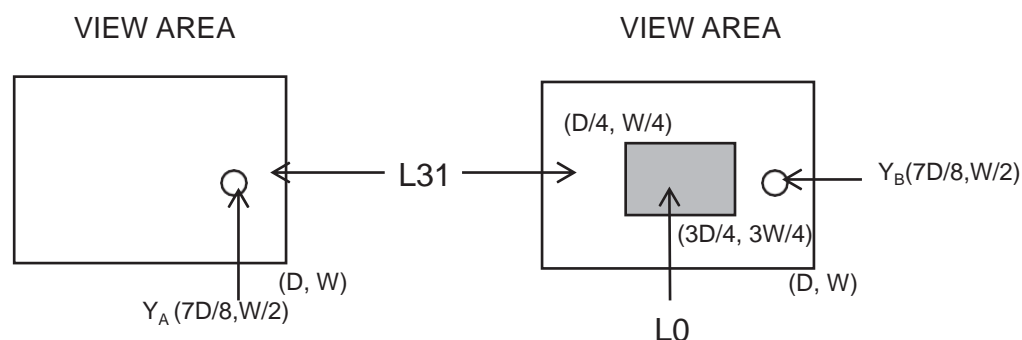

Figure 2. White Luminance and Uniformity Measurement Locations (9 points)



**Figure 3. Response Time Testing**

**Figure 4. Cross Modulation Test Description**

$$\text{Cross-Talk (\%)} = \left| \frac{Y_B - Y_A}{Y_A} \right| \times 100$$

Where:  $Y_A$  = Initial luminance of measured area ( $\text{cd/m}^2$ )

$Y_B$  = Subsequent luminance of measured area ( $\text{cd/m}^2$ )

The location measured will be exactly the same in both patterns

Figure 5. TFT-LCD Module Outline Dimensions (Front view)

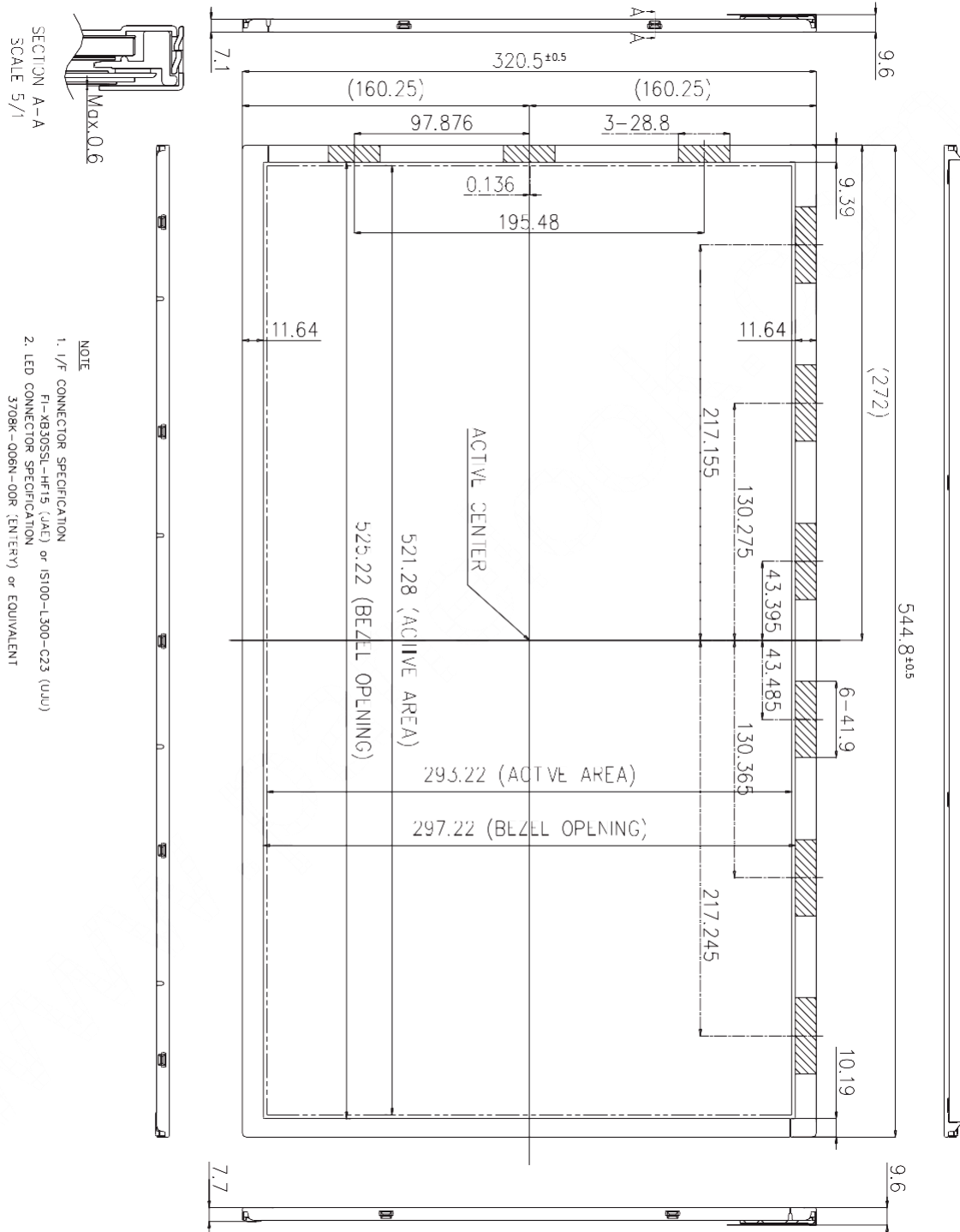

Figure 6. TFT-LCD Module Outline Dimensions (Rear view)

