



Product Specification

G156XW01 V1

AU OPTRONICS CORPORATION

() Preliminary Specification

(V) Final Specification

Module	15.6" Color TFT-LCD
Model Name	G156XW01 V1

Customer	Date
Note: This Specification is subject to change without notice.	
_____	_____
Approved by	
_____	_____

Approved by	Date
Audio-Video Business Unit / AU Optronics corporation	
<u>Crystal Hsieh</u>	<u>2015/03/20</u>
Prepared by	
<u>Sandy Su</u>	<u>2015/03/20</u>



Contents

1.0 Handling Precautions..... 4

2.0 General Description..... 5

 2.1 Display Characteristics..... 5

 2.2 Optical Characteristics..... 6

3.0 Functional Block Diagram..... 10

4.0 Absolute Maximum Ratings..... 11

 4.1 TFT LCD Module..... 11

 4.2 Absolute Ratings of Environment..... 11

5.0 Electrical characteristics..... 12

 5.1 TFT LCD Module..... 12

 5.1.1 Power Specification..... 12

 5.1.2 Signal Electrical Characteristics..... 13

 5.2 Backlight Unit..... 14

6.0 Signal Characteristic..... 15

 6.1 Pixel Format Image..... 15

 6.2 The input data format..... 15

 6.3 Signal Description..... 16

 6.4 Timing Characteristics..... 18

 6.5 Timing diagram..... 19

 6.6 Power ON/OFF Sequence..... 20

7.0 Connector & Pin Assignment..... 21

 7.1 TFT LCD Module..... 21

 7.1.1 Pin Assignment..... 21

 7.2 Backlight Unit..... 22

 7.2.1 LED Driver Connector Pin Assignment..... 22

8.0 Reliability Test..... 23

9.0 Packaging Spec..... 24

 9.1 Shipping Label..... 24

 9.2 Carton & Pallet Package..... 25

10.0 Mechanical Characteristics..... 26

 10.1 LCM Outline Dimension (Front View)..... 26

 10.2 LCM Outline Dimension (Rear View)..... 27

Record of Revision

Version and Date	Page	Old description	New Description	Remark
0.0 2011/5/24		First Edition for Customer	N/A	
1.0 2011/7/19	5	All input signals are LVDS interface and this module doesn't contain an inverter board for backlight.	All input signals are LVDS interface and this module contains with an LED driver for backlight.	
	5	Operating: 0 to +50	Operating: 0 to +60(+60 °C as panel surface temperature)	
	11	Operating Temperature max: +50	Operating Temperature max: +60	
	11	NA	Note 4	
	14	Parameter guideline for LED Inverter is under stable conditions at 25 °C	Parameter guideline for LED driver is under stable conditions at 25 °C	
	23	THO: Ta= 50 °C, 50%RH, 300hours	THO: Ta= 60 °C, 300hours	
1.1 2012/8/3	26	No Packaging Spec	Add Carton Package information	
1.2 2012/11/12	26	No Pallet Spec	Add Pallet Package information	
1.3 2014/05/22	5	White Luminance(Center): 300 cd/m2 (Typ.) LED Power Consumption: 10.5W (Typ.), 12W (Max.)	Update →400 cd/m2 (Typ.) Update →9.5W (Typ.), 10.5W (Max.)	
	6	Central Luminance: Min.240 Typ.300	Update →Min.320 Typ.400	
	14	Ivcc,Input Current:Typ 0.88- PLED,Power Consumption: Typ10.5, Max12 IF,LED Forward Current: Typ 80	→0.79 Update →Typ9.5, Max10.5 Update →Typ 50	
1.4 2014/09/01	5	LED Power Consumption: 9.5W (Typ.), 10.5W (Max.)	Update: →7.8W (Typ.), 8.5W (Max.)	
	10	Functional Block Diagram	Update	
	14	Ivcc,Input Current:Typ 0.79 PLED,Power Consumption: Typ9.5, Max10.5 No Enable	→0.64 Update →Typ7.8, Max8.5 Add Enable High-level:Min2,Low-level:Max0.2	
	22	#3 Enable,Signal name: 5V-On / 0V-Off	Update → LED enable	
1.5 2015/01/11	5	Support Color 16.7M colors (RGB 6-bit + Hi-FRC)	Amend →16.2M colors (RGB 6-bit + 2-FRC)	
1.6 2015/03/20	26	LCM Outline Dimension (Front View)	Update front bezel drawing	
	27	LCM Outline Dimension (Rear View)	Update front bezel drawing	
1.7 2015/06/10	14	Enable High-level	Add Max.5.5V	

1.0 Handling Precautions

- 1) Since front polarizer is easily damaged, pay attention not to scratch it.
- 2) Be sure to turn off power supply when inserting or disconnecting from input connector.
- 3) Wipe off water drop immediately. Long contact with water may cause discoloration or spots.
- 4) When the panel surface is soiled, wipe it with absorbent cotton or other soft cloth.
- 5) Since the panel is made of glass, it may break or crack if dropped or bumped on hard surface.
- 6) Since CMOS LSI is used in this module, take care of static electricity and insure human earth when handling.
- 7) Do not open or modify the Module Assembly.
- 8) Do not press the reflector sheet at the back of the module to any directions.
- 9) In case if a Module has to be put back into the packing container slot after once it was taken out from the container, do not press the center of the LED reflector edge. Instead, press at the far ends of the LED Reflector edge softly. Otherwise the TFT Module may be damaged.
- 10) At the insertion or removal of the Signal Interface Connector, be sure not to rotate nor tilt the Interface Connector of the TFT Module.
- 11) TFT-LCD Module is not allowed to be twisted & bent even force is added on module in a very short time. Please design your display product well to avoid external force applying to module by end-user directly.
- 12) Small amount of materials without flammability grade are used in the TFT-LCD module. The TFT-LCD module should be supplied by power complied with requirements of Limited Power Source (IEC60950 or UL1950), or be applied exemption.
- 13) Severe temperature condition may result in different luminance, response time.
- 14) Continuous operating TFT-LCD Module under high temperature environment may accelerate LED light bar exhaustion and reduce luminance dramatically.
- 15) The data on this specification sheet is applicable when TFT-LCD module is placed in landscape position.
- 16) Continuous displaying fixed pattern may induce image sticking. It's recommended to use screen saver or moving content periodically if fixed pattern is displayed on the screen.



2.0 General Description

This specification applies to the 15.6 inch-wide Color a-Si TFT-LCD Module G156XW01. The display supports the HD - 1366(H) x 768(V) screen format and 16.2M colors (RGB 6-bits + 2-FRC data). All input signals are LVDS interface and this module contains with an LED driver for backlight.

2.1 Display Characteristics

The following items are characteristics summary on the table under 25°C condition:

ITEMS	Unit	SPECIFICATIONS
Screen Diagonal	[mm]	15.6"
Active Area	[mm]	344.232 (H) x 193.536 (V)
Pixels H x V		1366(x3) x 768
Pixel Pitch	[um]	252 (per one triad) ×252
Pixel Arrangement		R.G.B. Vertical Stripe
Display Mode		TN Mode, Normally White
White Luminance (Center)	[cd/m ²]	400 cd/m ² (Typ.)
Contrast Ratio		500 (Typ.)
Optical Response Time	[msec]	8ms (Typ., on/off)
Nominal Input Voltage VDD	[Volt]	+5.0 V
LCD Power Consumption	[Watt]	2.15 W (Typ.), 2.5 W (Max.) (all black pattern)
LED Power Consumption	[Watt]	7.8 W (Typ.), 8.5 W (Max.) (all black pattern)
Weight	[g]	1250 (Typ.), 1350(Max.)
Physical Size	[mm]	363.8(W) X 215.9(H) X 16.85 (D) Typ.
Electrical Interface		One channel LVDS
Support Color		16.2M colors (RGB 6-bit + 2-FRC)
Surface Treatment		Anti-Glare, 3H
RoHS Compliance		RoHS Compliance
Temperature Range		
Operating	[°C]	0 to +60(+60 °C as panel surface temperature)
Storage (Non-Operating)	[°C]	-20 to +60



2.2 Optical Characteristics

The optical characteristics are measured under stable conditions at 25 °C:

Item	Unit	Conditions	Min.	Typ.	Max.	Note			
Viewing Angle	[degree]	Horizontal (Right) CR = 10 (Left)	75 75	85 85	- -	1,2			
		Vertical (Up) CR = 10 (Down)	70 70	80 80	- -				
		Horizontal (Right) CR = 5 (Left)	75 75	85 85	- -				
		Vertical (Up) CR = 5 (Down)	75 75	85 85	- -				
		Contrast ratio		Normal Direction	350		500	-	3
		Response Time	[msec]	Raising Time (T _r)	-		6	9	4
Falling Time (T _f)	-			2	4				
Raising + Falling	-			8	13				
Color / Chromaticity Coordinates (CIE)		Red x	0.591	0.641	0.691	5			
		Red y	0.293	0.343	0.393				
		Green x	0.276	0.326	0.376				
		Green y	0.567	0.617	0.667				
		Blue x	0.098	0.148	0.198				
		Blue y	0.014	0.064	0.114				
Color Coordinates (CIE) White		White x	0.263	0.313	0.363				
		White y	0.279	0.329	0.379				
Central Luminance	[cd/m ²]		320	400	-	6			
Luminance Uniformity	[%]		75	80	-	7			
Crosstalk (in 60Hz)	[%]				1.5	8			
Flicker	dB				-20	9			

Note 1: Measurement method

The LCD module should be stabilized at given temperature for 30 minutes to avoid abrupt temperature change during measuring (at surface 35 °C). In order to stabilize the luminance, the measurement should be executed after lighting Backlight for 30 minutes in a stable, windless and dark room.

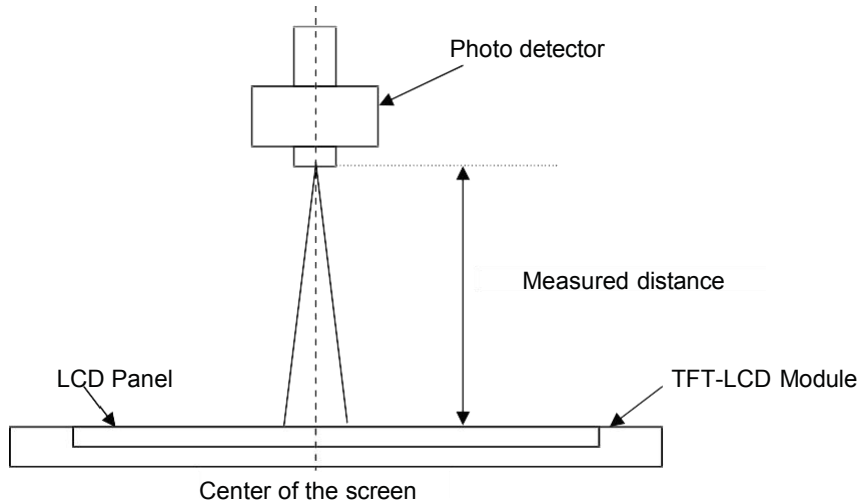

Note 2: Definition of viewing angle measured by ELDIM (EZContrast 88)

Viewing angle is the measurement of contrast ratio H10 and H5, at the screen center, over a 180° horizontal and 180° vertical range (off-normal viewing angles). The 180° viewing angle range is broken down as follows; 90° (θ) horizontal left and right and 90° (ϕ) vertical, high (up) and low (down). The measurement direction is typically perpendicular to the display surface with the screen rotated about its center to develop the desired measurement viewing angle.

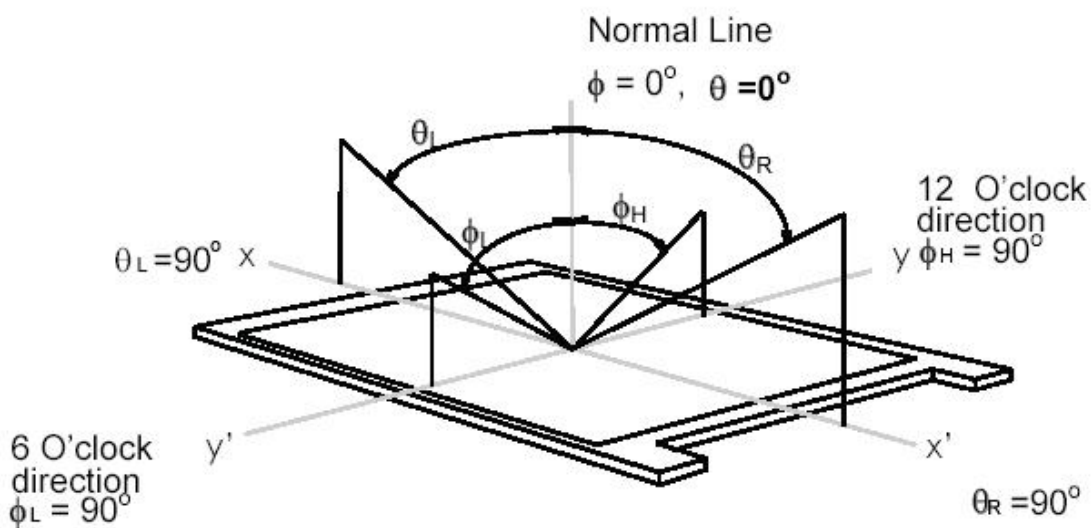



Note 3: Contrast ratio is measured by TOPCON SR-3

Note 4: Definition of Response time measured by Westar TRD-100A

The output signals of photo detector are measured when the input signals are changed from “Full Black” to “Full White” (rising time, Tr_R), and from “Full White” to “Full Black” (falling time, Tr_F), respectively. The response time is interval between the 10% and 90% (1 frame at 60 Hz) of amplitudes.

$Tr_R + Tr_F = 8 \text{ msec (typ.)\%}$

Note 5: Color chromaticity and coordinates (CIE) is measured by TOPCON SR-3

Note 6: Contrast response is measured by TOPCON SR-3

Note 7: Luminance uniformity of these 9 points is defined as below and measured by

TOPCON SR-3

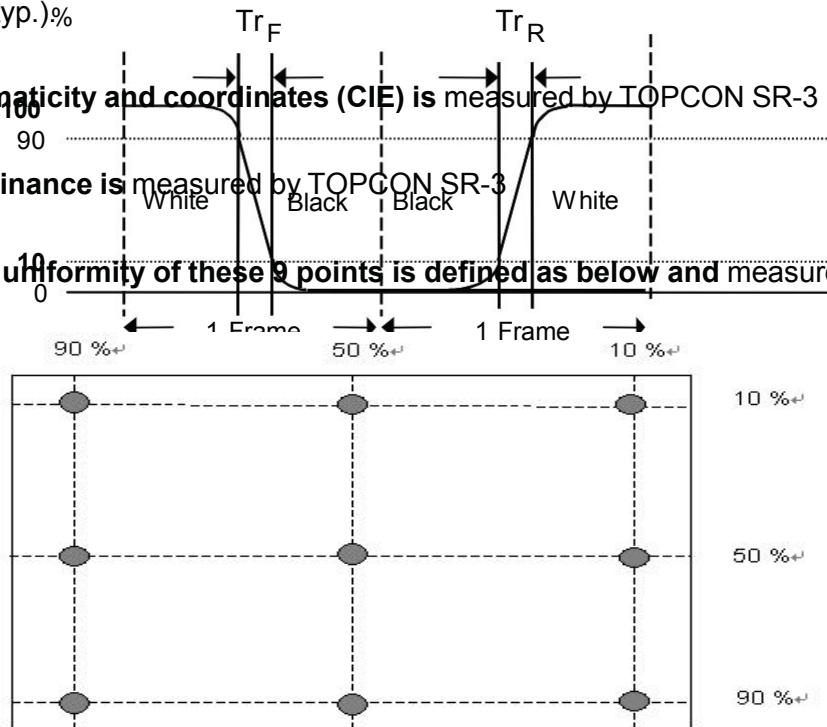

$$\text{Uniformity} = \frac{\text{Minimum Luminance in 9 points (1-9)}}{\text{Maximum Luminance in 9 Points (1-9)}}$$



Note 8: Crosstalk is defined as below and measured by TOPCON SR-3

$$CT = | YB - YA | / YA \times 100 (\%), \text{ Where}$$

YA = Luminance of measured location without gray level 0 pattern (cd/m²)

YB = Luminance of measured location with gray level 0 pattern (cd/m²)

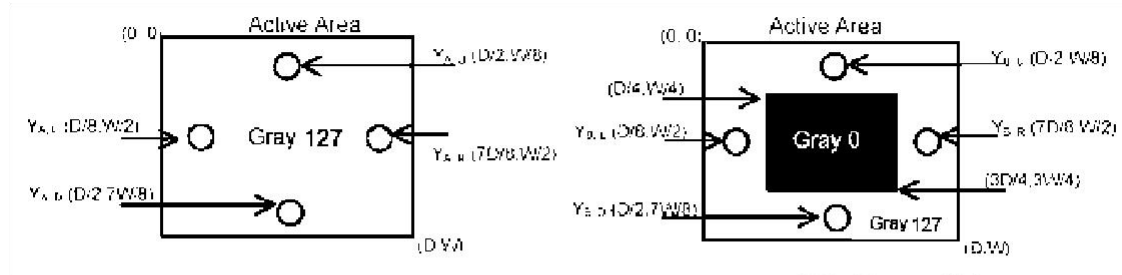

Note 9: Test Pattern: Subchecker Pattern measured by TOPCON SR-3

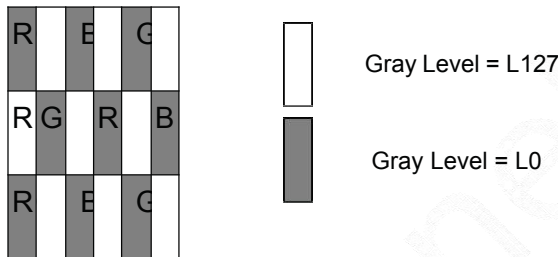

Method: Record dBV & DC value with TRD-100

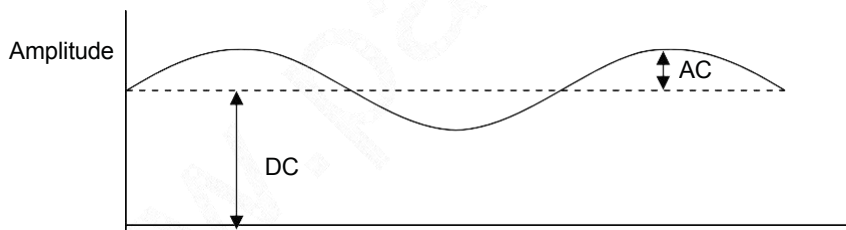

$$\text{Flicker (dB)} = 20 \log \frac{\text{AC Level (at 30 Hz)}}{\text{DC Level}}$$



3.0 Functional Block Diagram

The following diagram shows the functional block of the 15.6 inch Color TFT-LCD Module:

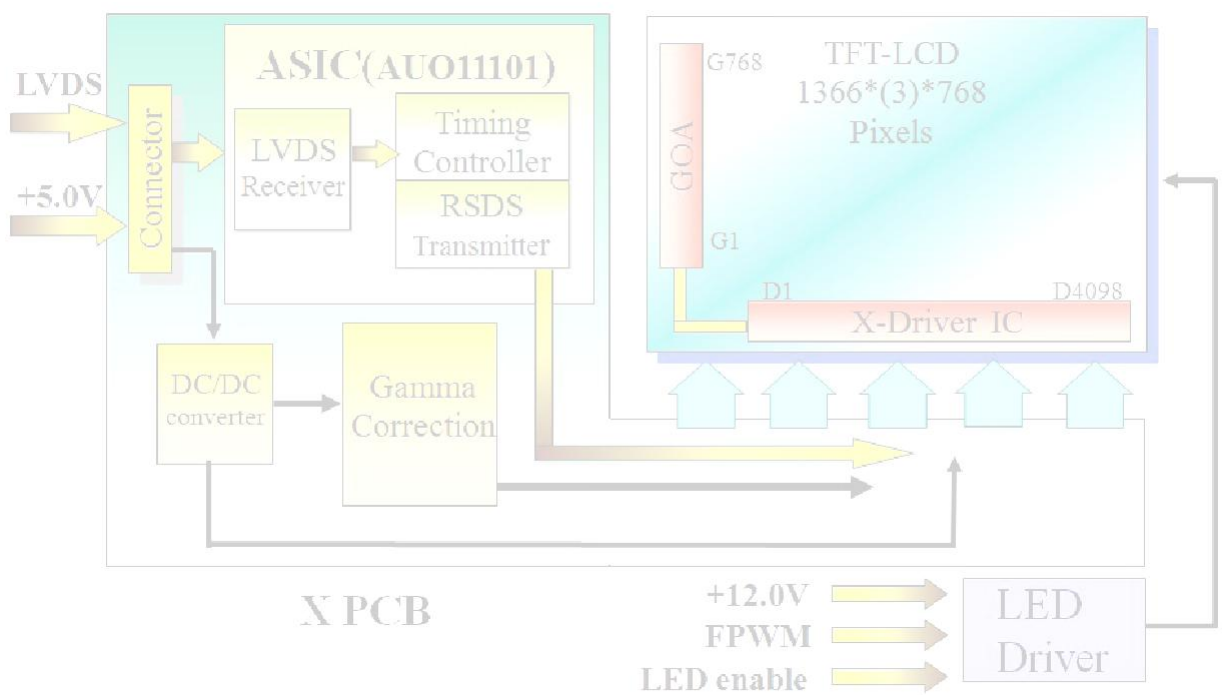

I/F PCB Connector:

JAE / FI-XB30SSL-HF15
STM / MSBKT2407P30HB

Housing Type:

FI-X30HL (Locked Type)

4.0 Absolute Maximum Ratings

Absolute maximum ratings of the module are as following:

4.1 TFT LCD Module

Item	Symbol	Min	Max	Unit	Conditions
Logic/LCD Drive Voltage	Vin	0	6.0	[Volt]	Note 1,2

4.2 Absolute Ratings of Environment

Item	Symbol	Min.	Max.	Unit	Conditions
Operating Temperature	TOP	0	+60	[°C]	Note 3
Operation Humidity	HOP	5	90	[%RH]	
Storage Temperature	TST	-20	+60	[°C]	
Storage Humidity	HST	5	90	[%RH]	

Note 1: With in Ta (25°C)

Note 2: Permanent damage to the device may occur if exceeding maximum values

Note 3: For quality performance, please refer to AUO IIS(Incoming Inspection Standard).

Note 4: Operation Temperature + 60°C is defined as panel surface temperature.

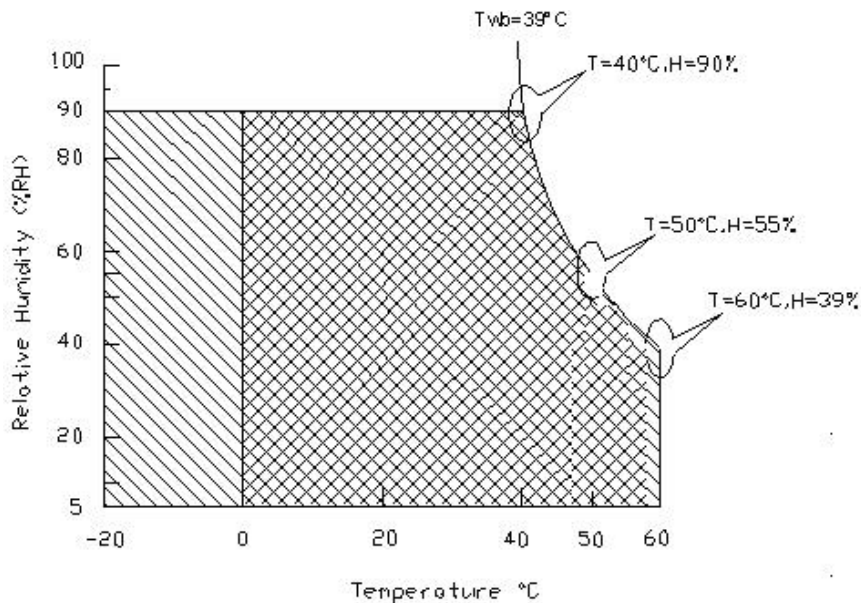

Operating Range  Storage Range  + 

5.0 Electrical characteristics

5.1 TFT LCD Module

5.1.1 Power Specification

Input power specifications are as following:

Symbol	Parameter	Min	Typ	Max	Unit	Conditions
VDD	Logic/LCD Drive Voltage	4.5	5.0	5.5	[Volt]	+/-10%
IDD	Input Current	-	0.43	0.5	[A]	VDD= 5.0V, All Black Pattern At 60Hz
PDD	VDD Power	-	2.15	2.5	[Watt]	VDD= 5.0V, All Black Pattern At 60Hz
IRush	Inrush Current	-	-	2.5	[A]	Note 1
VDDrp	Allowable Logic/LCD Drive Ripple Voltage	-	-	300	[mV] p-p	VDD= 5.0V, All Black Pattern At 60Hz

Note 1: Measurement conditions:

The duration of rising time of power input is 470 us.

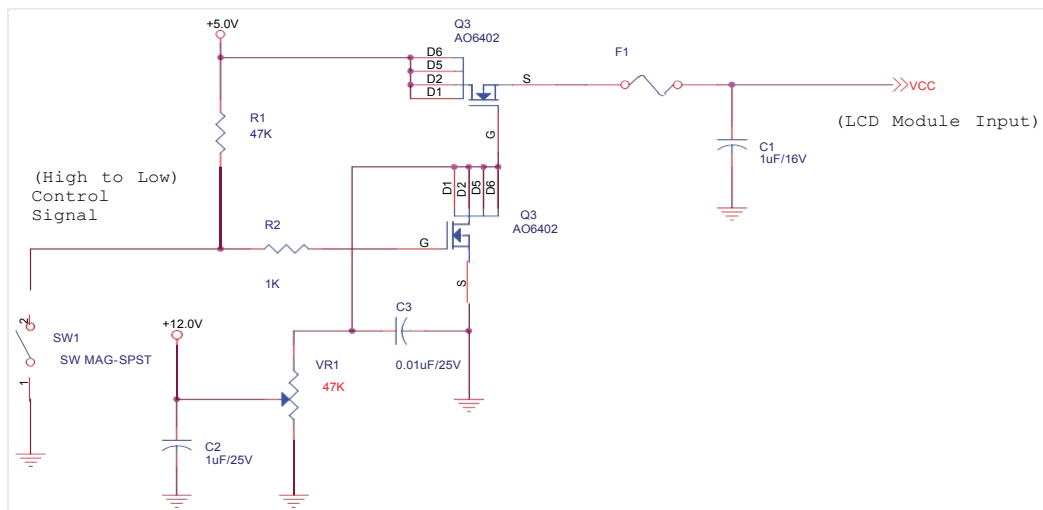

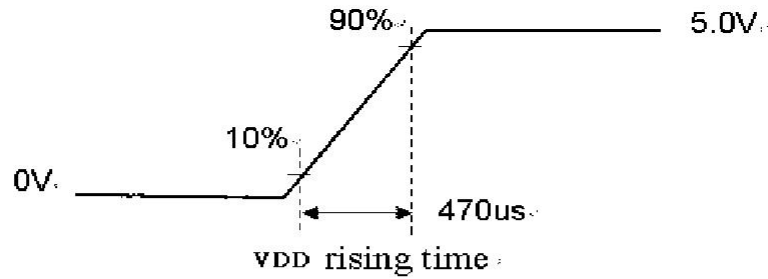

5.1.2 Signal Electrical Characteristics

Input signals shall be low or Hi-Z state when VDD is off. Please refer to specifications of SN75LVDS82DGG (Texas Instruments) in detail.

Characteristics of each signal are as following:

Symbol	Parameter	Min	Typ	Max	Units	Condition
VTH	Differential Input High Threshold	-	+50	+100	[mV]	VICM = 1.2V Note 1
VTL	Differential Input Low Threshold	-100	-50	-	[mV]	VICM = 1.2V Note 1
VID	Input Differential Voltage	100	-	600	[mV]	Note 1
VICM	Differential Input Common Mode Voltage	+1.0	+1.2	+1.5	[V]	VTH-VTL = 200mV (max) Note 1

Note 1: LVDS Signal Waveform

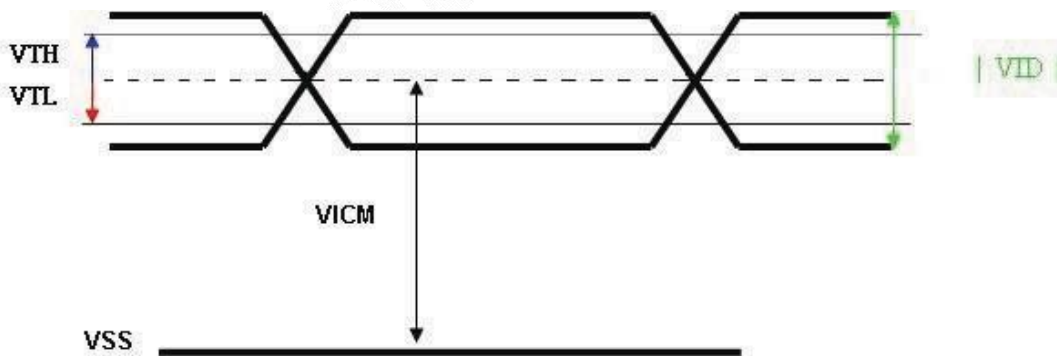



5.2 Backlight Unit

Parameter guideline for LED driver is under stable conditions at 25 °C (Room Temperature):

Symbol	Parameter	Min	Typ	Max	Unit	Remark
Vcc	Input Voltage	10.8	12	13.2	Volt	
Ivcc	Input Current	-	0.64	-	A	100% Dimming
PLED	Power Consumption	-	7.8	8.5	Watt	100% Dimming
FPWM	PWM Dimming Frequency	200	-	20k	Hz	
	Swing Voltage	3	3.3	5	V	
	Dimming Duty Cycle	5	-	100	%	
Enable	High-level	2	-	5.5	V	
	Low-level	0	-	0.2	V	
I _F	LED Forward Current	-	50	-	mA	Ta = 25°C
Operating Life		50000	-	-	Hrs	Ta = 25°C

Note 1: Ta means ambient temperature of TFT-LCD module.

Note 2: If G156XW01 V1 module is driven at high ambient temperature & humidity condition. The operating life will be reduced.

Note 3: Operating life means brightness goes down to 50% initial brightness. Min. operating life time is estimated data.



6.0 Signal Characteristic

6.1 Pixel Format Image

Following figure shows the relationship of the input signals and LCD pixel format.

6.2 The input data format

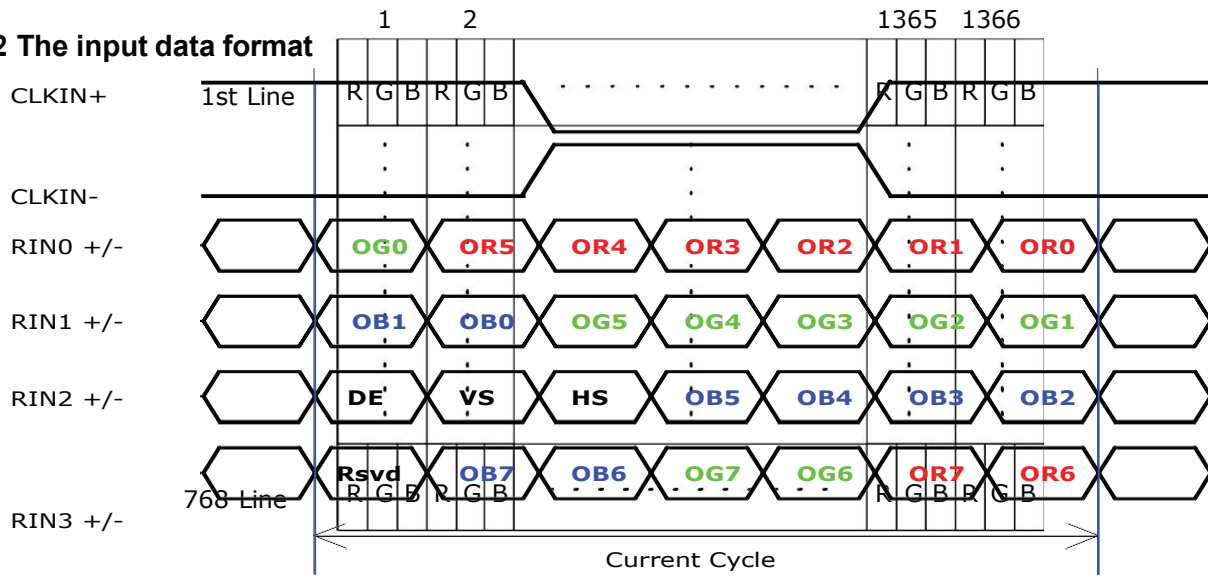

Note 1: R/G/B data 7:MSB, R/G/B data 0:LSB



6.3 Signal Description

The module using one LVDS receiver SN75LVDS82(Texas Instruments). LVDS is a differential signal technology for LCD interface and high speed data transfer device. LVDS transmitters shall be SN75LVDS83(negative edge sampling). The first LVDS port(RxOxxx) transmits odd pixels while the second LVDS port(RxExxx) transmits even pixels.

PIN #	SIGNAL NAME	DESCRIPTION
1	Reserved	No Connection
2	Reserved	No Connection
3	Reserved	No Connection
4	GND	Ground
5	RXIN0-	-LVDS Differential Data Input, CH0
6	RXIN0+	+LVDS Differential Data Input, CH0
7	GND	Ground
8	RXIN1-	-LVDS Differential Data Input, CH1
9	RXIN1+	+LVDS Differential Data Input, CH1
10	GND	Ground
11	RXIN2-	-LVDS Differential Data Input, CH2
12	RXIN2+	+LVDS Differential Data Input, CH2
13	GND	Ground
14	RXCLKIN-	-LVDS Differential Clock Input, CH3
15	RXCLKIN+	+LVDS Differential Clock Input, CH3
16	GND	Ground
17	RXIN3-	-LVDS Differential Data Input, CH3
18	RXIN3+	+LVDS Differential Data Input, CH3
19	GND	Ground
20	Reserved	Internal used (recommend no connection)
21	Reserved	Internal used (recommend no connection)
22	Reserved	Internal used (recommend no connection)
23	GND	Ground
24	GND	Ground
25	GND	Ground
26	AVDD	Power +5V, (typical)
27	AVDD	Power +5V, (typical)
28	AVDD	Power +5V, (typical)
29	AVDD	Power +5V, (typical)
30	AVDD	Power +5V, (typical)



Note1: Start from left side

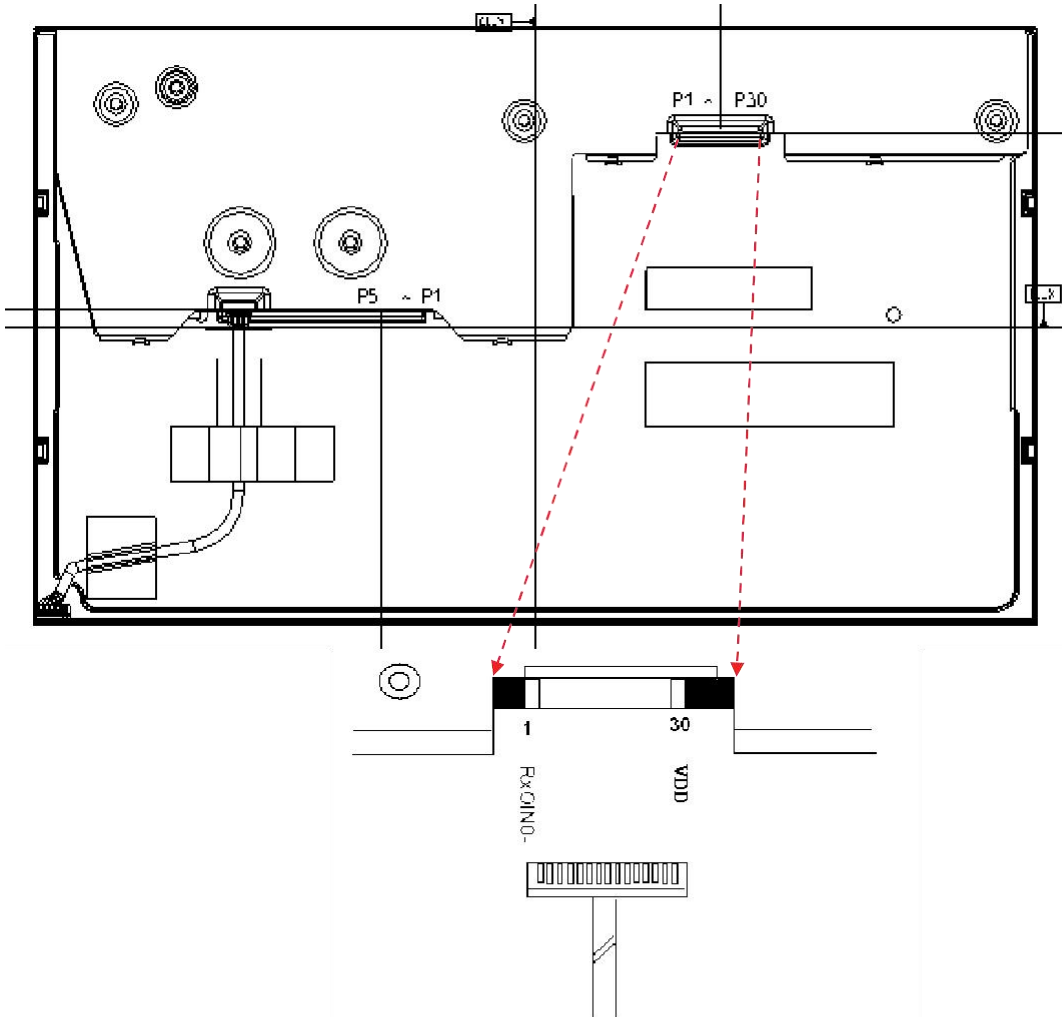



6.4 Timing Characteristics

Basically, interface timing described here is not actual input timing of LCD module but close to output timing of SN75LVDS82DGG (Texas Instruments) or equivalent.

Item		Symbol	Min	Typ	Max	Unit
Data CLK		Tclk	60	76	90	[MHz]
H-section	Period	Th	1446	1560	1936	[Tclk]
	Display Area	Tdisp(h)	1366	1366	1366	[Tclk]
	Blanking	Tblk(h)	80	200	570	[Tclk]
V-section	Period	Tv	778	806	888	[Th]
	Display Area	Tdisp(v)	768	768	768	[Th]
	Blanking	Tblk(v)	10	38	120	[Th]
Frame Rate		F	50	60	75	[Hz]

Note : DE mode only



6.5 Timing diagram

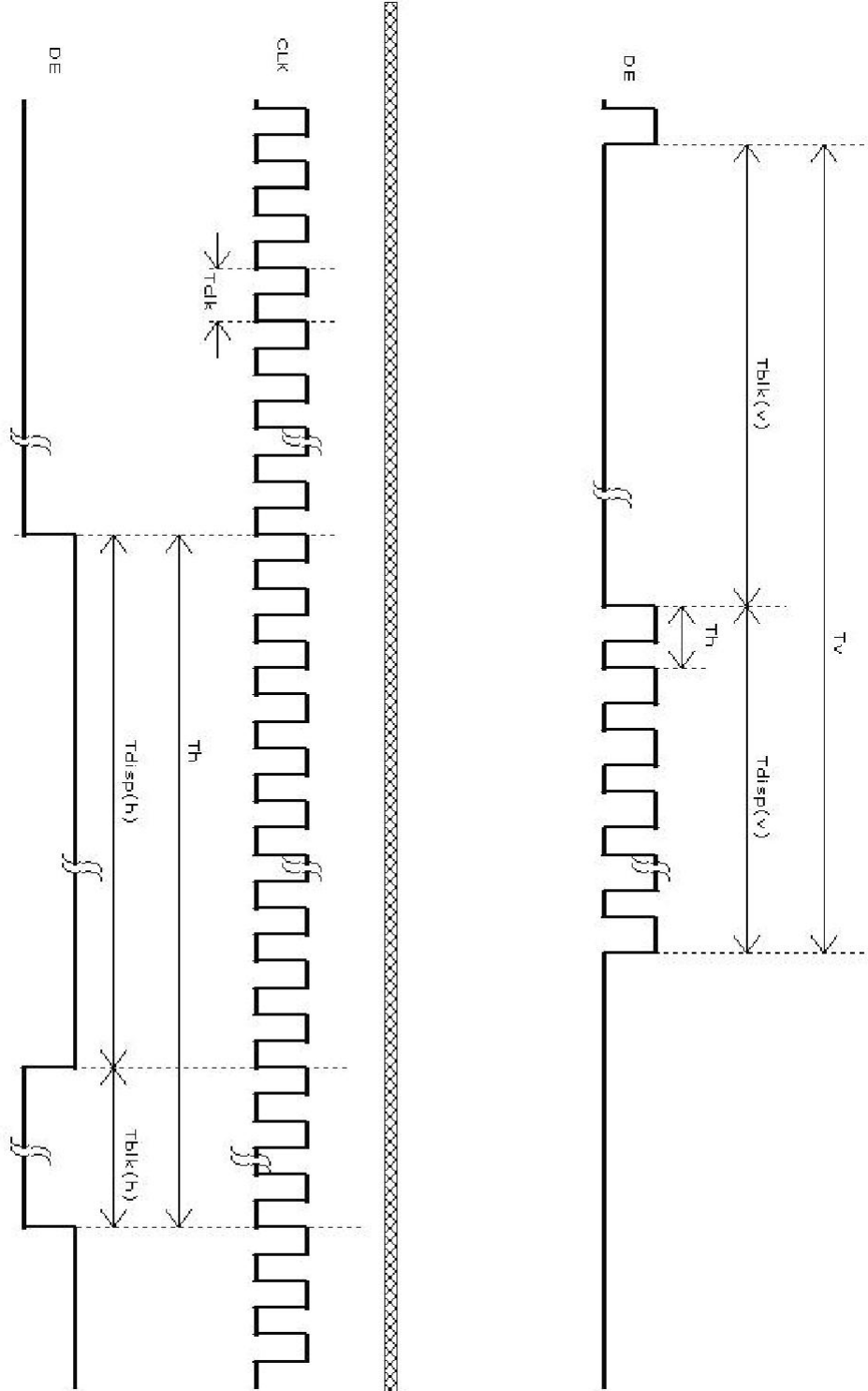

6.6 Power ON/OFF Sequence

VDD power and LED on/off sequence are as follows. Interface signals are also shown in the chart. Signals from any system shall be Hi-Z state or low level when VDD is off.

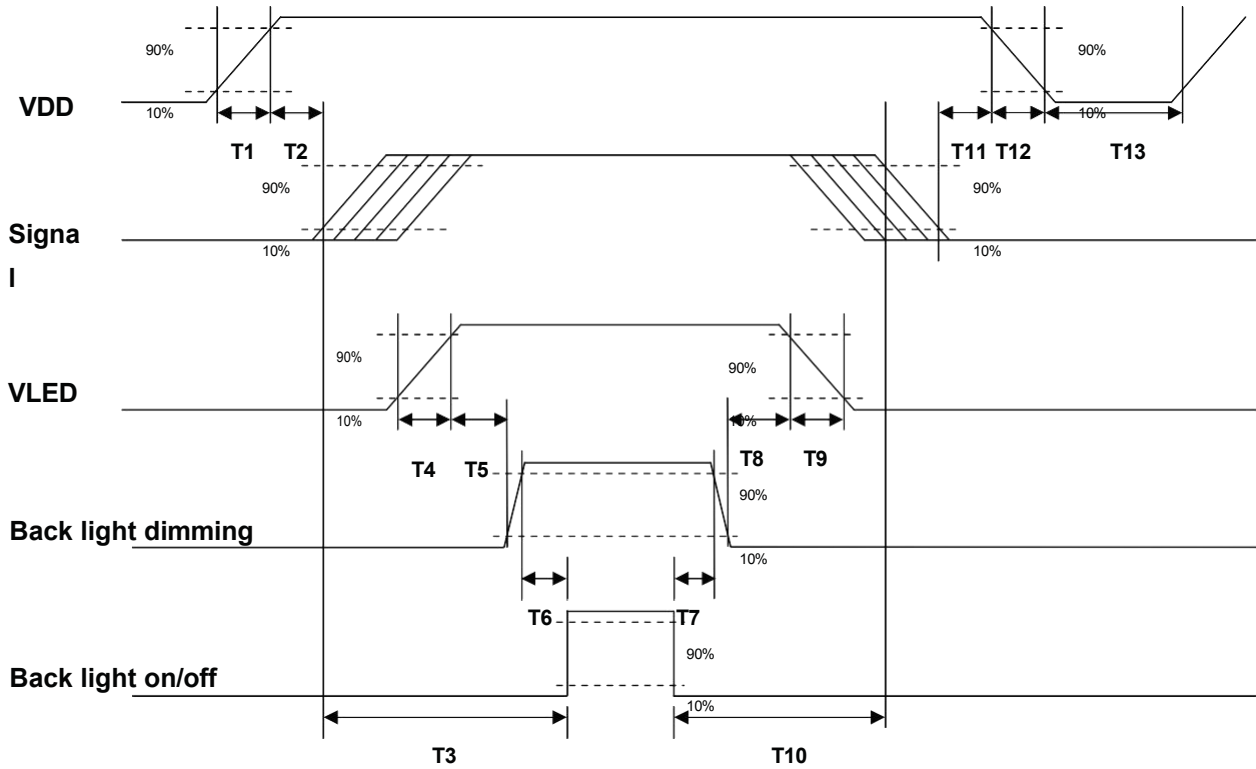

Parameter	Value			Units
	Min.	Typ.	Max.	
T1	0.5	-	10	[ms]
T2	0	40	50	[ms]
T3	200	-	-	[ms]
T4	0.5	-	10	[ms]
T5	10	-	-	[ms]
T6	10	-	-	[ms]
T7	0	-	-	[ms]
T8	10	-	-	[ms]
T9	-	-	10	[ms]
T10	110	-	-	[ms]
T11	0.5	16	50	[ms]
T12	-	-	100	[ms]
T13	1000	-	-	[ms]



7.0 Connector & Pin Assignment

Physical interface is described as for the connector on module. These connectors are capable of accommodating the following signals and will be following components.

7.1 TFT LCD Module

Connector Name / Designation	Interface Connector / Interface card
Manufacturer	JAE STM
Type Part Number	FI-XB30SSL-HF15 MSBKT2407P30HB
Mating Housing Part Number	FI-X30HL (Locked Type)

7.1.1 Pin Assignment

Pin#	Signal Name	Pin#	Signal Name
1	Reserved	2	Reserved
3	Reserved	4	GND
5	RXIN0-	6	RXIN0+
7	GND	8	RXIN1-
9	RXIN1+	10	GND
11	RXIN2-	12	RXIN2+
13	GND	14	RXCLKIN-
15	RXCLKIN+	16	GND
17	RXIN3-	18	RXIN3+
19	GND	20	Reserved
21	Reserved	22	Reserved
23	GND	24	GND
25	GND	26	AVDD
27	AVDD	28	AVDD
29	AVDD	30	AVDD



7.2 Backlight Unit

Physical interface is described as for the connector on module. These connectors are capable of accommodating the following signals and will be following components.

Connector Name / Designation	LED Connector
Manufacturer	E&T or compatible
Connector Model Number	3808K-F05N-02R or compatible
Mating Connector Model Number	H208K-P05N-02B or compatible

7.2.1 LED Driver Connector Pin Assignment

Pin#	Symbol	Signal Name
1	Vcc	12V
2	GND	GND
3	Enable	LED enable
4	Dimming	PWM Dimming
5	NC	NC



8.0 Reliability Test

Environment test conditions are listed as following table.

Items	Required Condition	Note
Temperature Humidity Bias (THB)	Ta= 50 °C, 80%RH, 300hours	
High Temperature Operation (HTO)	Ta= 60 °C, 300hours	
Low Temperature Operation (LTO)	Ta= 0 °C, 300hours	
High Temperature Storage (HTS)	Ta= 60 °C, 300hours	
Low Temperature Storage (LTS)	Ta= -20 °C, 300hours	
Vibration Test (Non-operation)	Acceleration: 1.5 Grms Wave: Random Frequency: 10 - 200 Hz Duration: 30 Minutes each Axis (X, Y, Z)	
Shock Test (Non-operation)	Acceleration: 50 G Wave: Half-sine Active Time: 20 ms Direction: ±X, ±Y, ±Z (one time for each Axis)	
Drop Test	Height: 46 cm, package test	
Thermal Shock Test (TST)	-20 °C /30min, 60 °C /30min, 100 cycles	1
On/Off Test	On/10sec, Off/10sec, 30,000 cycles	
ESD (Electro Static Discharge)	Contact Discharge: ± 8KV, 150pF(330Ω) 1sec, 15 points, 25 times/ point.	2
	Air Discharge: ± 15KV, 150pF(330Ω) 1sec 15 points, 25 times/ point.	
Altitude Test	Operation:10,000 ft Non-Operation:30,000 ft	

Note 1: The TFT-LCD module will not sustain damage after being subjected to 100 cycles of rapid temperature change. A cycle of rapid temperature change consists of varying the temperature from -20 °C to 60 °C, and back again. Power is not applied during the test. After temperature cycling, the unit is placed in normal room ambient for at least 4 hours before power on.

Note 2: EN61000-4-2, ESD class B: Certain performance degradation allowed

- No data lost
- Self-recoverable
- No hardware failures.



Product Specification

G156XW01 V1

AU OPTRONICS CORPORATION

9.0 Packaging Spec

9.1 Shipping Label

The label is on the panel as shown below:

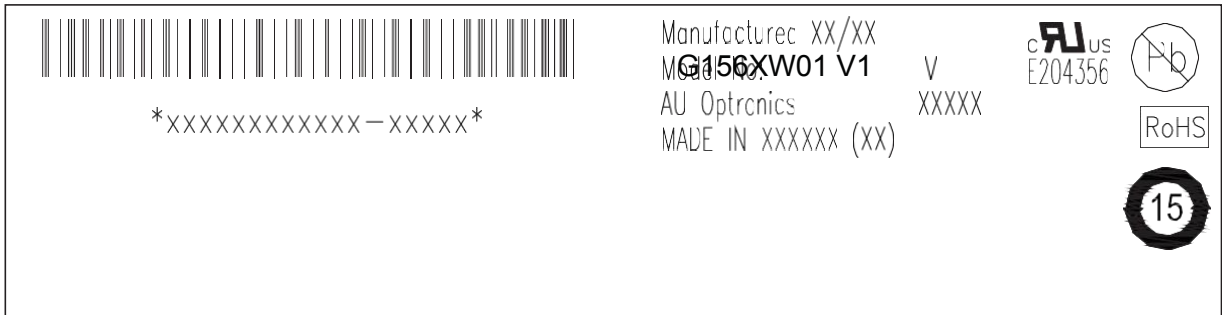

Note 1: For Pb Free products, AUO will add  for identification.

Note 2: For RoHS compatible products, AUO will add  for identification.

Note 3: For China RoHS compatible products, AUO will add  for identification.

Note 4: The Green Mark will be presented only when the green documents have been ready by AUO Internal Green Team.



9.2 Carton & Pallet Package

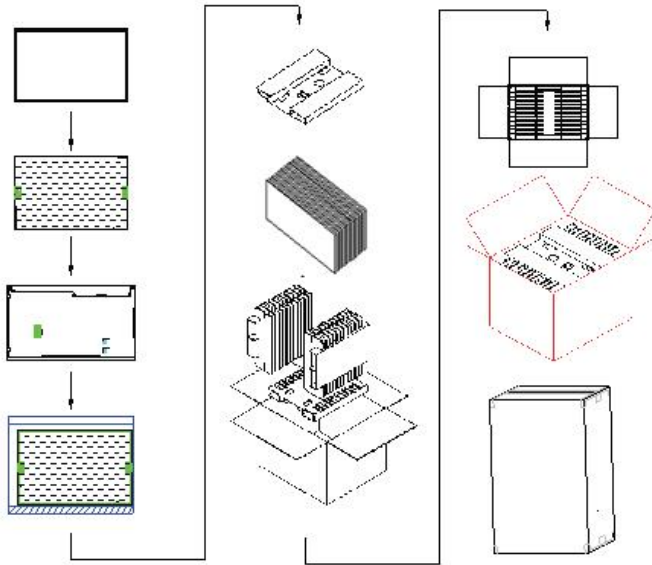

Max capacity K 11 TFT-LCD module per carton

Max weight: 16.3 kg per carton

Outside dimension of carton: 443mm(L)*365mm(W)*299mm(H)

Pallet size K 1150 mm * 910 mm * 132mm

Box stacked

Module by air K (2 *3) *4 layers Δ one pallet put 24 boxes Δ total 264pcs module

Module by sea K (2 *3) *3 layers Δ two pallet put 36 boxes Δ total 396pcs module

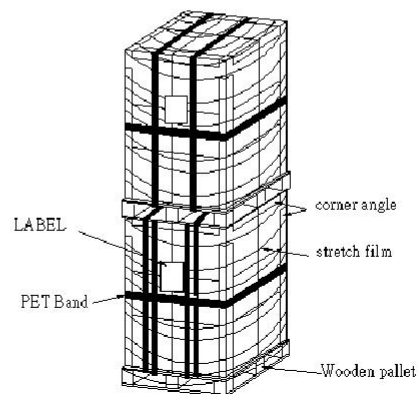
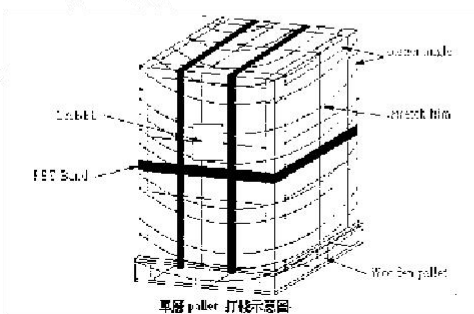

By air K one pallet

10.0 Mechanical Characteristics

10.1 LCM Outline Dimension (Front View)

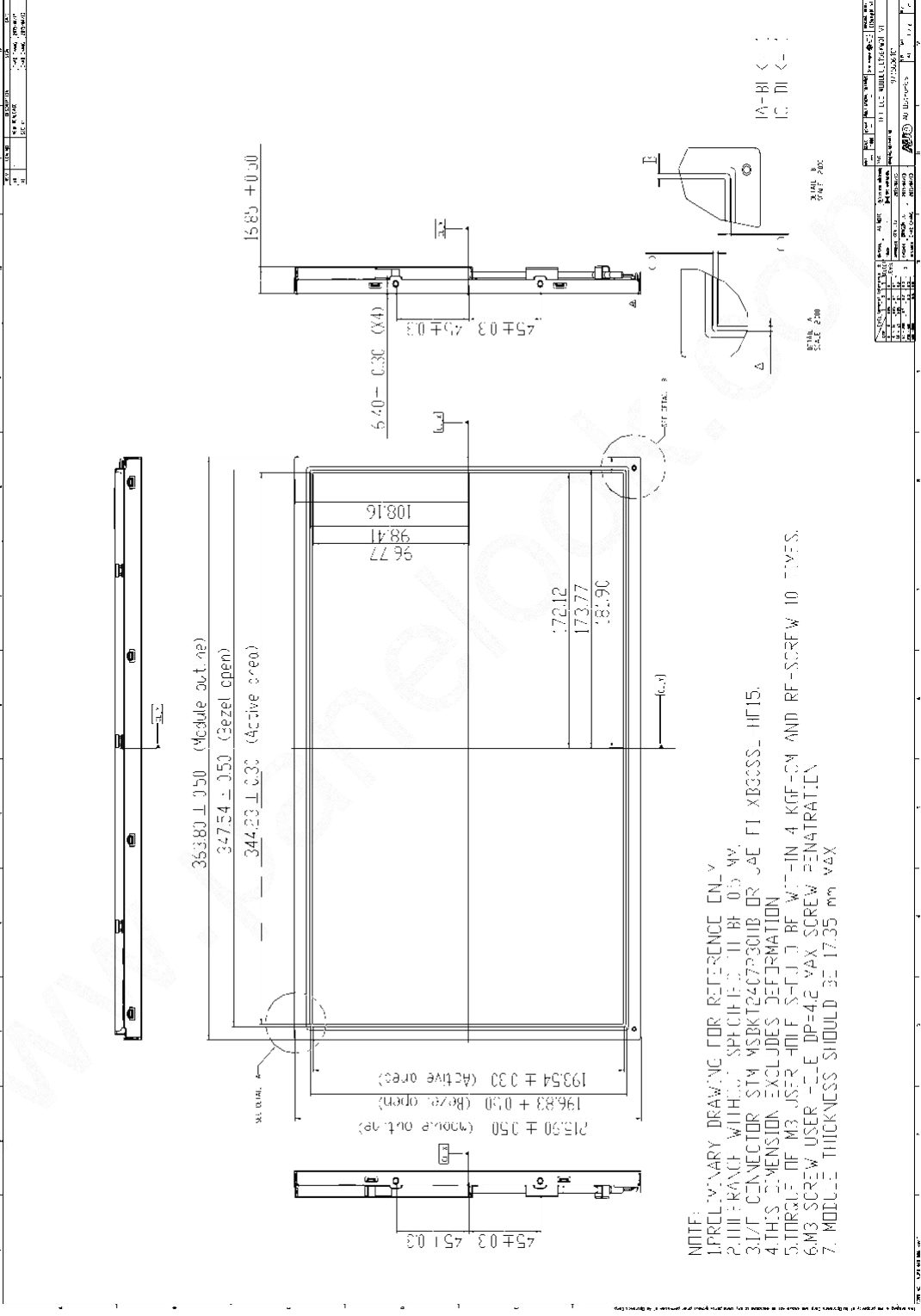

10.2 LCM Outline Dimension (Rear View)

